

# z/VM Systems Management Fundamentals

## The Strategies and Options

March 28, 2014 v2.3

Bill Bitner  
z/VM Customer Focus and Care  
[bitnerb@us.ibm.com](mailto:bitnerb@us.ibm.com)



## Trademarks

The following are trademarks of the International Business Machines Corporation in the United States and/or other countries.

BladeCenter*	FICON*	Performance Toolkit for VM	Storwize*	System z10*	zSecure
DB2*	GDPS*	Power*	System Storage*	Tivoli*	z/VM*
DS6000*	HiperSockets	PowerVM	System x*	zEnterprise*	
DS8000*	HyperSwap	PR/SM	System z*	z/OS*	
ECKD	OMEGAMON*	RACF*	System z9*		

\* Registered trademarks of IBM Corporation

The following are trademarks or registered trademarks of other companies.

Adobe, the Adobe logo, PostScript, and the PostScript logo are either registered trademarks or trademarks of Adobe Systems Incorporated in the United States, and/or other countries.

Cell Broadband Engine is a trademark of Sony Computer Entertainment, Inc. in the United States, other countries, or both and is used under license therefrom.

Intel, Intel logo, Intel Inside, Intel Inside logo, Intel Centrino, Intel Centrino logo, Celeron, Intel Xeon, Intel SpeedStep, Itanium, and Pentium are trademarks or registered trademarks of Intel Corporation or its subsidiaries in the United States and other countries.

IT Infrastructure Library is a registered trademark of the Central Computer and Telecommunications Agency which is now part of the Office of Government Commerce.

ITIL is a registered trademark, and a registered community trademark of the Office of Government Commerce, and is registered in the U.S. Patent and Trademark Office.

Java and all Java based trademarks and logos are trademarks or registered trademarks of Oracle and/or its affiliates.

Linear Tape-Open, LTO, the LTO Logo, Ultrium, and the Ultrium logo are trademarks of HP, IBM Corp. and Quantum in the U.S. and

Linux is a registered trademark of Linus Torvalds in the United States, other countries, or both.

Microsoft, Windows, Windows NT, and the Windows logo are trademarks of Microsoft Corporation in the United States, other countries, or both.

OpenStack is a trademark of OpenStack LLC. The OpenStack trademark policy is available on the [OpenStack website](#).

TEALEAF is a registered trademark of Tealeaf, an IBM Company.

Windows Server and the Windows logo are trademarks of the Microsoft group of countries.

Worklight is a trademark or registered trademark of Worklight, an IBM Company.

UNIX is a registered trademark of The Open Group in the United States and other countries.

\* Other product and service names might be trademarks of IBM or other companies.

### Notes:

Performance is in Internal Throughput Rate (ITR) ratio based on measurements and projections using standard IBM benchmarks in a controlled environment. The actual throughput that any user will experience will vary depending upon considerations such as the amount of multiprogramming in the user's job stream, the I/O configuration, the storage configuration, and the workload processed. Therefore, no assurance can be given that an individual user will achieve throughput improvements equivalent to the performance ratios stated here.

IBM hardware products are manufactured from new parts, or new and serviceable used parts. Regardless, our warranty terms apply.

All customer examples cited or described in this presentation are presented as illustrations of the manner in which some customers have used IBM products and the results they may have achieved. Actual environmental costs and performance characteristics will vary depending on individual customer configurations and conditions.

This publication was produced in the United States. IBM may not offer the products, services or features discussed in this document in other countries, and the information may be subject to change without notice. Consult your local IBM business contact for information on the product or services available in your area.

All statements regarding IBM's future direction and intent are subject to change or withdrawal without notice, and represent goals and objectives only.

Information about non-IBM products is obtained from the manufacturers of those products or their published announcements. IBM has not tested those products and cannot confirm the performance, compatibility, or any other claims related to non-IBM products. Questions on the capabilities of non-IBM products should be addressed to the suppliers of those products.

Prices subject to change without notice. Contact your IBM representative or Business Partner for the most current pricing in your geography.

This information provides only general descriptions of the types and portions of workloads that are eligible for execution on Specialty Engines (e.g., zIIPs, zAAPs, and IFLs) ("SEs"). IBM authorizes customers to use IBM SE only to execute the processing of Eligible Workloads of specific Programs expressly authorized by IBM as specified in the "Authorized Use Table for IBM Machines" provided at [www.ibm.com/systems/support/machine\\_warranties/machine\\_code/aut.html](http://www.ibm.com/systems/support/machine_warranties/machine_code/aut.html) ("AUT"). No other workload processing is authorized for execution on an SE. IBM offers SE at a lower price than General Processors/Central Processors because customers are authorized to use SEs only to process certain types and/or amounts of workloads as specified by IBM in the AUT.

## Notice Regarding Specialty Engines (e.g., zIIPs, zAAPs and IFLs):

Any information contained in this document regarding Specialty Engines ("SEs") and SE eligible workloads provides only general descriptions of the types and portions of workloads that are eligible for execution on Specialty Engines (e.g., zIIPs, zAAPs, and IFLs). IBM authorizes customers to use IBM SE only to execute the processing of Eligible Workloads of specific Programs expressly authorized by IBM as specified in the "Authorized Use Table for IBM Machines" provided at [www.ibm.com/systems/support/machine\\_warranties/machine\\_code/aut.html](http://www.ibm.com/systems/support/machine_warranties/machine_code/aut.html) ("AUT").

No other workload processing is authorized for execution on an SE.

IBM offers SEs at a lower price than General Processors/Central Processors because customers are authorized to use SEs only to process certain types and/or amounts of workloads as specified by IBM in the AUT.

## Agenda

- Overview
  - Definition of “Systems Management”
  - Systems Management Discipline
  - z/VM Systems Management Related Interfaces
  - xCAT
  - OpenStack Enablement
  - IBM Wave for z/VM
  
- High-level Strategy
  
- Product and Offering Survey

## Definition of Systems Management

- Means different things to different people
  - Worth asking your audience what it means and level-setting on a definition
    - What do you mean by “manage”?  
Install? Configure? Change? Clone? Provision?
- “Any product or process that is not involved in actually using the system for the purpose it was purchased.”
- What it does **not** cover, at least in this presentation:
  - Initial installation & initial configuration of disks, memory, devices
- Systems Management needs may mature/expand over time.

# Dimensions of Systems Management

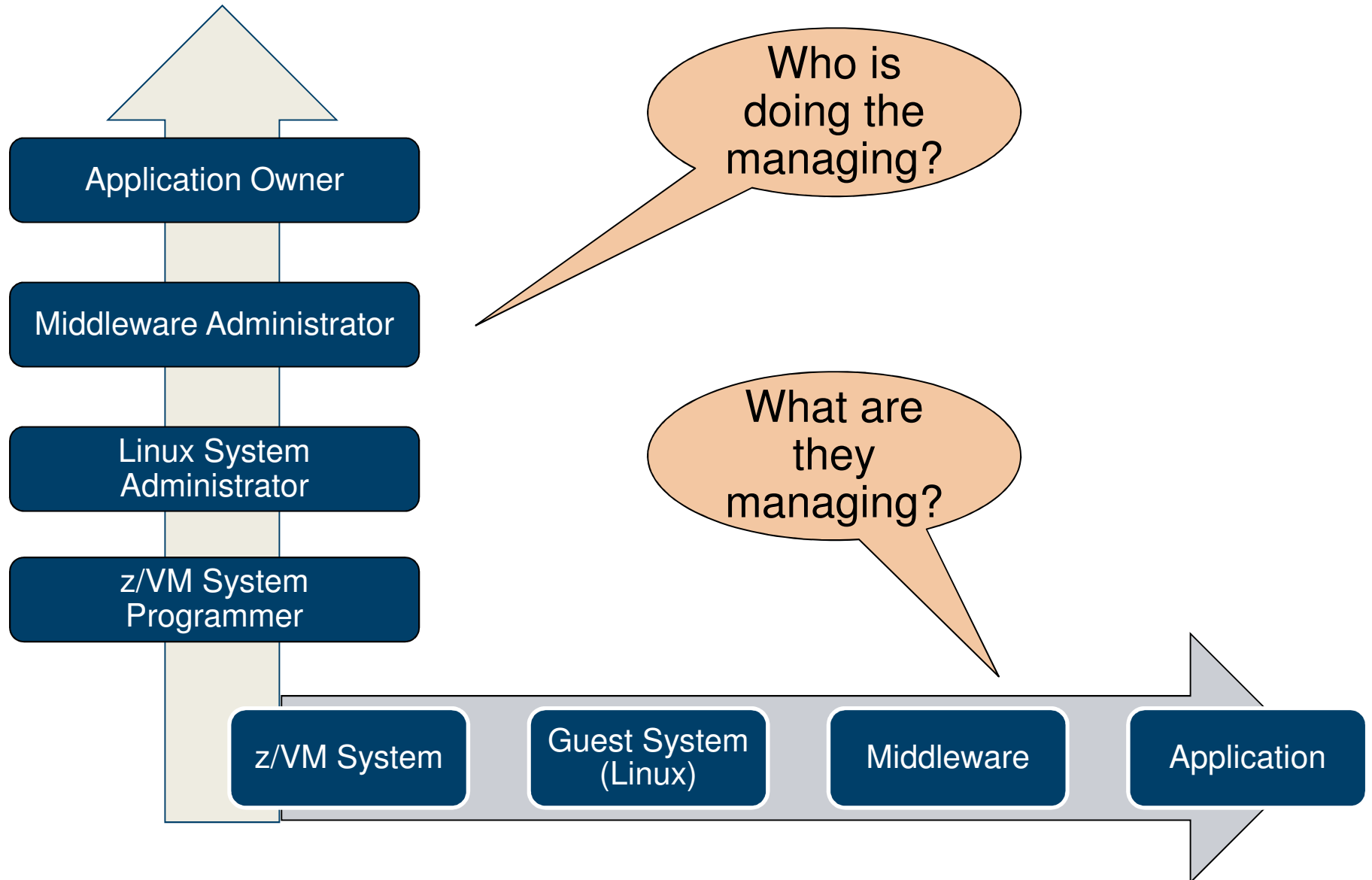

## Your Investment Portfolio

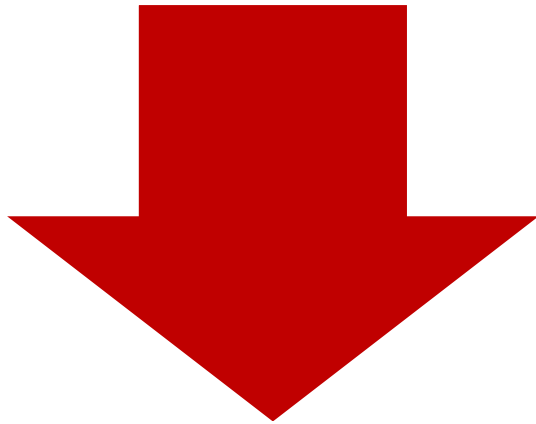

### Buy

- Solutions
- Integration
- Support



### Do It Yourself

- Develop Solutions
- Integrate Solutions
- On going support



## Disciplines of Systems Management

### Automation

- Scheduling and running common events and processes

### Monitoring

- Monitor and acting on events and conditions of the system

### Business Continuity

- Disaster Recovery and Backups/Restores

### Data Management

- Tape and storage management

### Accounting

- Charge back and billing; Inventory

### Security

- Enforcing permissions, tracking, and auditing.

### Performance

- Performance Management and Capacity Planning

### Provisioning

- Creating and changing the resources and configurations of virtual machines and perhaps guest systems



## Interface Layers

User Presentation

Wrapper and APIs

Automation

Monitoring

Business  
Continuity

Data  
Management

Monitoring

Accounting

Security

Performance

Provisioning

## Systems Management Related APIs and Interfaces

- CP Exit Support
  
- CP System Services
  - \*ACCOUNT
  - \*MONITOR
  - \*RPI
  - \*VMEVENT
  
- Systems Management APIs (SMAPI)
  
- xCAT REST APIs
  
- OpenStack Enablement

## CP Exit Support

- CP Exit Support (aka “CP Exits”)
- Long History of customer and ISV extensions to the z/VM Hypervisor
- Typically used by ISVs and a small subset of customers with very specific modifications to the control program
- Can add or delete:
  - CP commands
  - Diagnose codes
  - Locally-developed CP message repositories
  - CP exit routines
- Dynamically loaded code
- 23 IBM defined CP Exit Points
  - Pre- and Post-processing Logon command
  - Shutdown command screening
  - Separator Page processing
  - Live Guest Relocation processing
- Defining and overriding commands
- z/VM CP Exit Customization SC24-6176

## CP System Services

- Allow programmatic interface with the z/VM Control Program
- IUCV (Inter User Communication Vehicle) connection to CP
- Most common used by various systems management tools and products:
  - \*ACCOUNT
    - Collects resource usage information for virtual machines and certain other audit like functions.
  - \*MONITOR
    - Collects thousands of data points about performance on a system, device, and virtual machine basis
    - Uses memory shared between CP and the virtual machine application to share the actual data
  - \*RPI – Access Verification System Service
    - Allows interaction between CP and an External Security Manager (ESM) such as Resource Access Control Facility (RACF)
  - \*VMEVENT
    - Allows notification to an application of significant system events, such as virtual machines logging on/off and relocation
- Most are documented in the z/VM CP Programming Services Manual SC24-6179
  - \*MONITOR is in z/VM Performance Manual SC24-6208

## z/VM Systems Management APIs

- Intended for use by ISVs and IBM program products for managing the z/VM System
- Socket-based server replaced Remote Procedure Call server in z/VM 5.3
  - RPC Server support dropped in z/VM 6.1
- Three types of API functions are supported for managing the z/VM system and virtual machines (images):
  - IBM-supplied directory manager functions
  - IBM-supplied non-directory manager functions
  - Customer-defined functions.

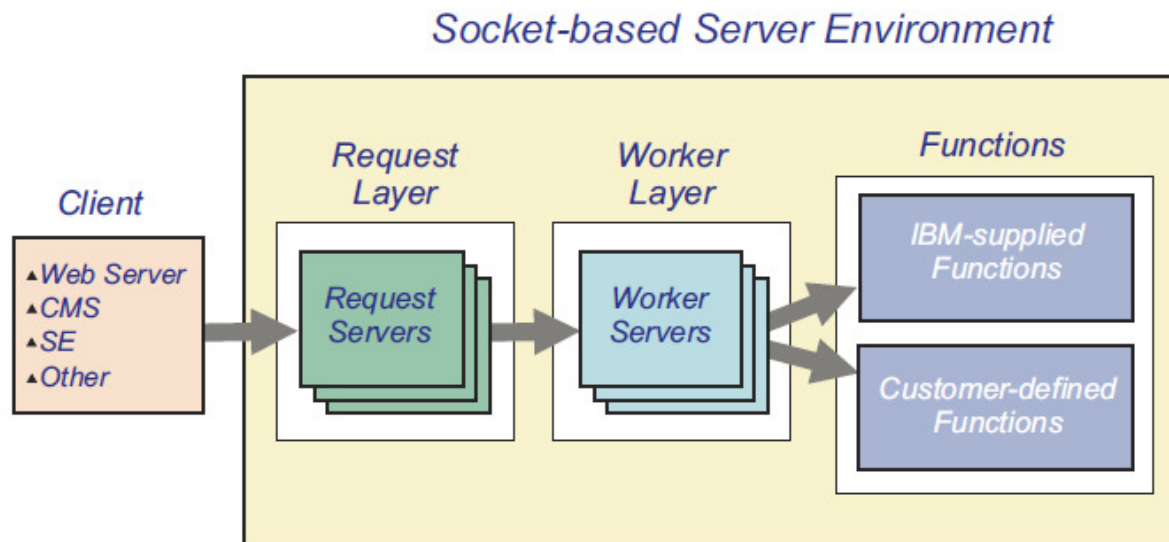

## Categories of SMAPI functions

- ABEND Dump Management
- Authorization
- Directory Manager Control
- Directory Manager Local Tag and Scan
- Directory Parsing
- Directory Update Subscription
- Disk Management
- Event Management
- Image Characteristics
- Image Connectivity
- Image CPUs
- Image Devices
- Image IPL Management
- Image Operations
- Image Volume Management
- List-Directed IPL
- Name List
- Profile Management
- Prototype Management
- Response Recovery
- Server
- Shared Memory Management
- Single System Image (SSI) Cluster Management
- System Configuration
- VMRM Configuration Update

## xCAT – Extreme Cloud Administration Toolkit

- Open Source tool to manage, provision, and monitor physical and virtual machines on all IBM architectures.
- Made available as a download and customer install in July 2012
- Integrated into the base of z/VM 6.3 in July 2013
- xCAT has four different interfaces
  - REST APIs (Representational State Transfer) – used by OpenStack Solutions
  - Browser based Graphical User Interface
  - Command Line Interface (CLI)
    - Available via downloadable xCAT
    - Available with VM65460 in z/VM 6.3 integrated xCAT (PTF UM34206)
  - XML

## Where does xCAT fit in?

- It provides the tools you need to administer your cloud
  - Automate redundant steps, e.g. Linux installation
  - Manage virtual resources
  
- xCAT is not a cloud operating system
  - You still need to tell xCAT what to do
  - You still need a z/VM system administrator
  
- xCAT is a toolkit
  - Equivalent to virt-manager or virsh for KVM
  - Tool to manage, provision, and monitor physical and virtual machines on IBM System x®, Power Systems®, and IBM System z
  - Provides rudimentary cloud functionality
  
- Value
  - Low overhead and lightweight (download ~100 MB)
  - Open source (EPL)
  - Cross platform



## xCAT History

- Developed by IBM starting in 1999 to manage clusters of Linux and AIX systems.
- Released to the Open Source community under the Eclipse Public License
- Used to manage clusters such as
  - Roadrunner, the fastest computer in the world in 2008
  - Watson, the IBM machine that competed and won on Jeopardy
- Today xCAT can manage physical or virtual machines, such as: RHEL, CentOS, Fedora, SLES, AIX, Windows, VMWare, KVM, PowerVM, z/VM.

Source: [http://sourceforge.net/apps/mediawiki/xcat/index.php?title=Main\\_Page](http://sourceforge.net/apps/mediawiki/xcat/index.php?title=Main_Page)

## Examples of Supported xCAT Features

- Automation
  - Power on/off virtual machine
  
- Provisioning virtual machine and host
  - Create/change/delete a virtual machine
  - Add/delete virtual network devices to a virtual machine
  - Provisioning diskless virtual machine using an NFS read-only root filesystem
  - Add/delete ECKD/SCSI disk to a virtual machine
  - Add/delete ECKD/SCSI disk to the system disk pool
  - Create/change/delete layer 2 or 3 QDIO Guest LAN or Vswitch
  - Cloning virtual machines
  - Plain installation of Linux via AutoYast or Kickstart

---

## Examples of Supported xCAT Features

- Accounting
  - Software and hardware inventory of a virtual machine
  
- Performance
  - System resource inventory (e.g. disks, networks)
  
- Business Continuity
  - Live Guest Relocation

# z/VM 6.3 Pre-Installed Systems Management

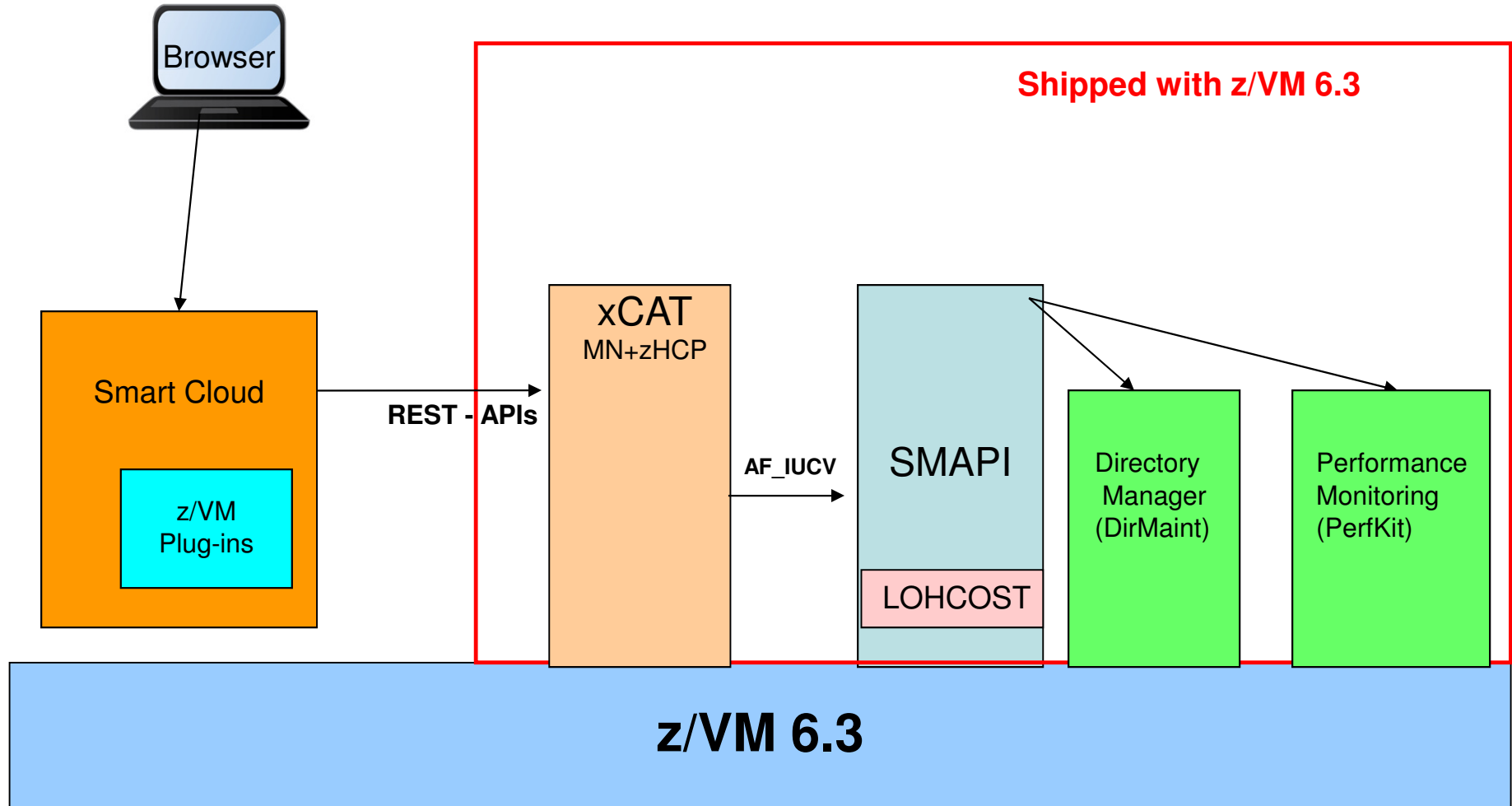

- Versions of DirMaint and Performance Toolkit are included free of charge with the SMAPI server, but these versions of the products only communicate with SMAPI, there is no way to interact with them directly.

# How xCAT Manages z/VM

**zHardware Control Point:**  
 Manages other VMs via Systems Management APIs and CP Commands. Each z/VM system needs to have a zHCP

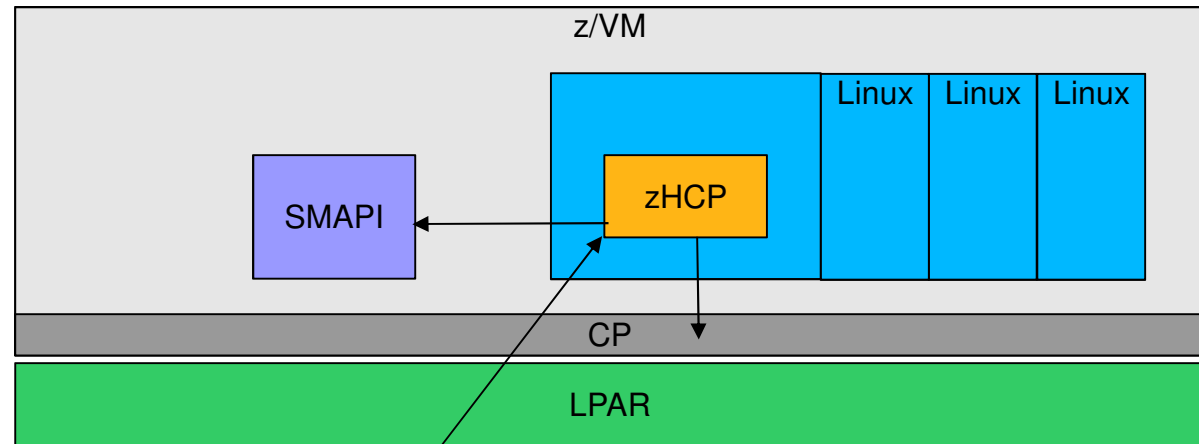

SSH

**xCAT Maintenance Node:** Central management server. Only one MN is needed for multiple systems.

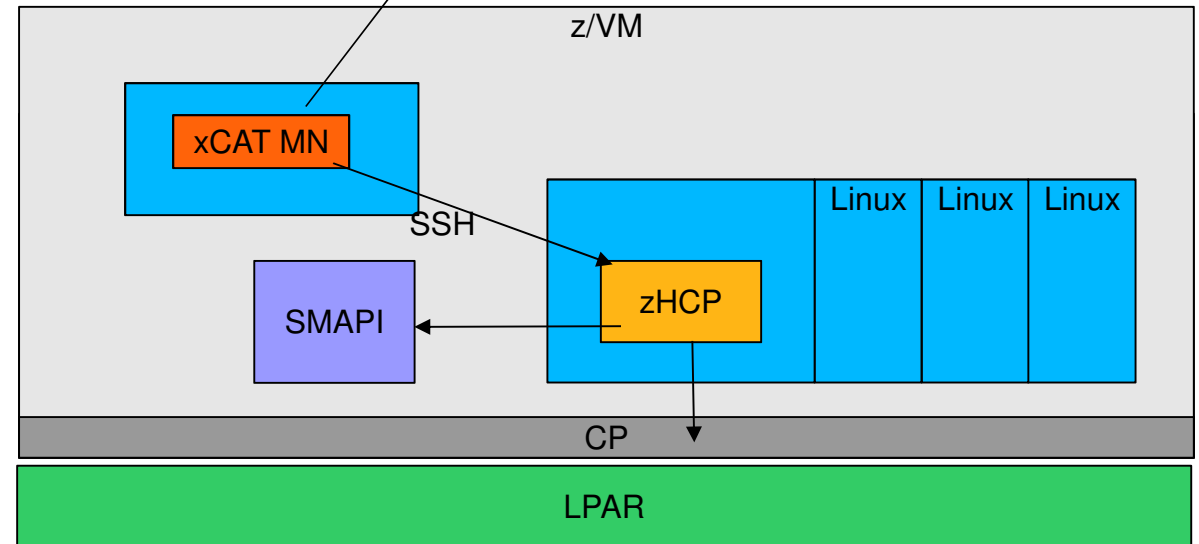

## xCAT Resources

- xCAT wiki for z/VM – Information on using xCAT
  - [http://sourceforge.net/apps/mediawiki/xcat/index.php?title=Main\\_Page](http://sourceforge.net/apps/mediawiki/xcat/index.php?title=Main_Page)
  
- xCAT YouTube channel: Various Demonstrations
  - <http://www.youtube.com/user/xcatuser>
  
- xCAT user mailing list
  - [xcat-user@lists.sourceforge.net](mailto:xcat-user@lists.sourceforge.net)
  
- z/VM Home Page
  - <http://www.vm.ibm.com/sysman/>
  
- xCAT Downloadable References
  - [http://sourceforge.net/apps/mediawiki/xcat/index.php?title=Download\\_xCAT](http://sourceforge.net/apps/mediawiki/xcat/index.php?title=Download_xCAT)
  - [http://sourceforge.net/apps/mediawiki/xcat/index.php?title=XCAT\\_Documentation](http://sourceforge.net/apps/mediawiki/xcat/index.php?title=XCAT_Documentation)
  - <http://xcat.sourceforge.net/pdf/xCAT-UI-Tutorial.pdf>
  - [http://sourceforge.net/apps/mediawiki/xcat/index.php?title=XCAT\\_zVM\\_Setup](http://sourceforge.net/apps/mediawiki/xcat/index.php?title=XCAT_zVM_Setup)

# Hybrid computing model integrated and enabled for Cloud

**Service Management Layer** (provided by SmartCloud technologies)



z/VM    zManager    kvm    Hyper-V    Power VC    FSM    VMware



**Datawarehousing**  
IBM DB2® Analytics  
Accelerator Solution

**zManager for z/OS  
and IBM zEnterprise  
BladeCenter®  
Extension (zBX)**

**Systems Director for Power®  
IBM System x® and storage**

**FSM for Intel®  
and Power ITEs**

**Third party  
Managers and  
Servers**

# The OpenStack Food Chain

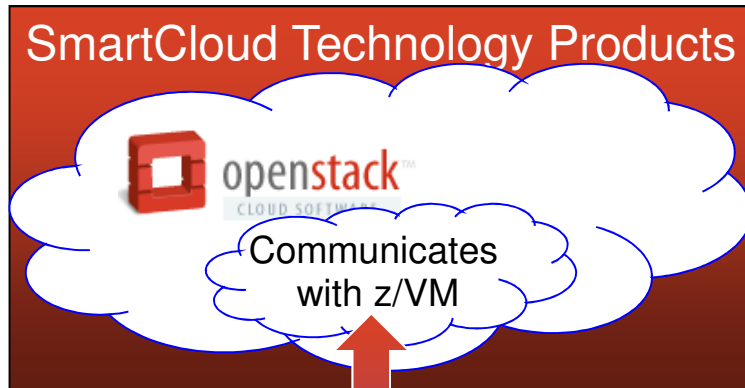

- **Top Half of the Solution:**
  - An IBM SmartCloud Technology product or other vendor product will include the OpenStack support.
  - Portions of that OpenStack support will know z/VM (i.e. code that connects and understands how to talk to z/VM).
- **Bottom Half of the Solution:**
  - Rest APIs are used to communicate with the OpenStack code from the top half.
  - The xCAT Appliance utilizes new and existing Systems Management APIs (SMAPI) to interact with the z/VM system
  - SMAPI can interact with additional products or features (e.g. a directory manager).

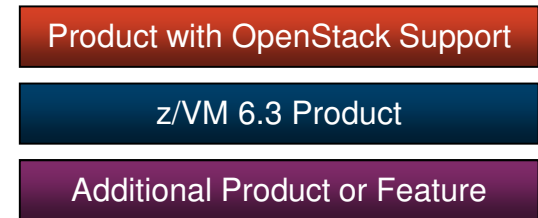



## OpenStack

- Open Source project to provide Infrastructure as a Service.
- Started by NASA and Rackspace in 2010
- Now backed by IBM and many other corporations
- Consists of separate projects to handle different types of resources
- New releases every 6 months

Source: [http://sourceforge.net/apps/mediawiki/xcat/index.php?title=Main\\_Page](http://sourceforge.net/apps/mediawiki/xcat/index.php?title=Main_Page)



# OpenStack Community

More than 6000 people and 100 companies

Active online community through mailing lists, IRC, wiki

Bi-yearly design summits

Companies need to donate money AND people that **ACTIVELY** contribute

## Platinum Members



AT&T



Canonical



HP



IBM

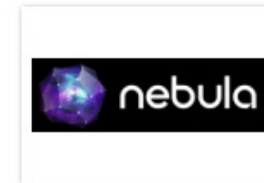

Nebula



Rackspace



Red Hat, Inc.



SUSE

and many more ...

<http://www.OpenStack.org/foundation/companies/>

## OpenStack Release Names

- These codenames are chosen by popular vote using the basic Launchpad poll feature over the ~openstack group. Codenames are cities or counties near where the corresponding OpenStack design summit took place. An exception (called the Waldon exception) is granted to elements of the state flag that sound especially cool.
- **Austin:** The first design summit took place in Austin, TX
- **Bexar:** The second design summit took place in San Antonio, TX
- **Cactus:** Cactus is a city in Texas
- **Diablo:** Diablo is a city in the bay area near Santa Clara, CA
- **Essex:** Essex is a city near Boston, MA
- **Folsom:** Folsom is a city near San Francisco, CA
- **Grizzly:** Grizzly is an element of the state flag of California
  - design summit takes place in San Diego, CA
- **Havana:** Havana is an unincorporated community in Oregon
  - design summit takes place in Oregon
- **Icehouse:** Ice House is a street in Hong Kong

## OpenStack Project Commitment

### Top 10 Contributors to OpenStack by Release

Essex April 2012			Folsom Sept 2012			Grizzly April 2013		
	Commits	Authors		Commits	Authors		Commits	Authors
Rackspace	2,275	52	Rackspace	973	49	Red Hat	1,854	38
Red Hat	507	12	Red Hat	861	15	Rackspace	944	58
Nebula	431	8	Nebula	464	9	IBM	895	41
HP	261	21	HP	179	25	HP	401	49
Canonical	118	7	Isi	144	3	Nebula	286	10
Nicira	105	3	Cloudscaling	140	4	Intel	243	13
Citrix	87	9	IBM	139	16	eNovance	238	7
Enovance	54	2	Sina	135	18	VMware	186	4
Cloudscaling	52	1	Canonical	108	5	Cloudscaling	175	3
Isi	40	2	Inktank	90	2	Dreamhost	171	7

Source: [bitergia.com](http://bitergia.com)

# OpenStack Projects

Six core projects delivering an IaaS solution plus a project delivering an Object Storage solution

## Focus

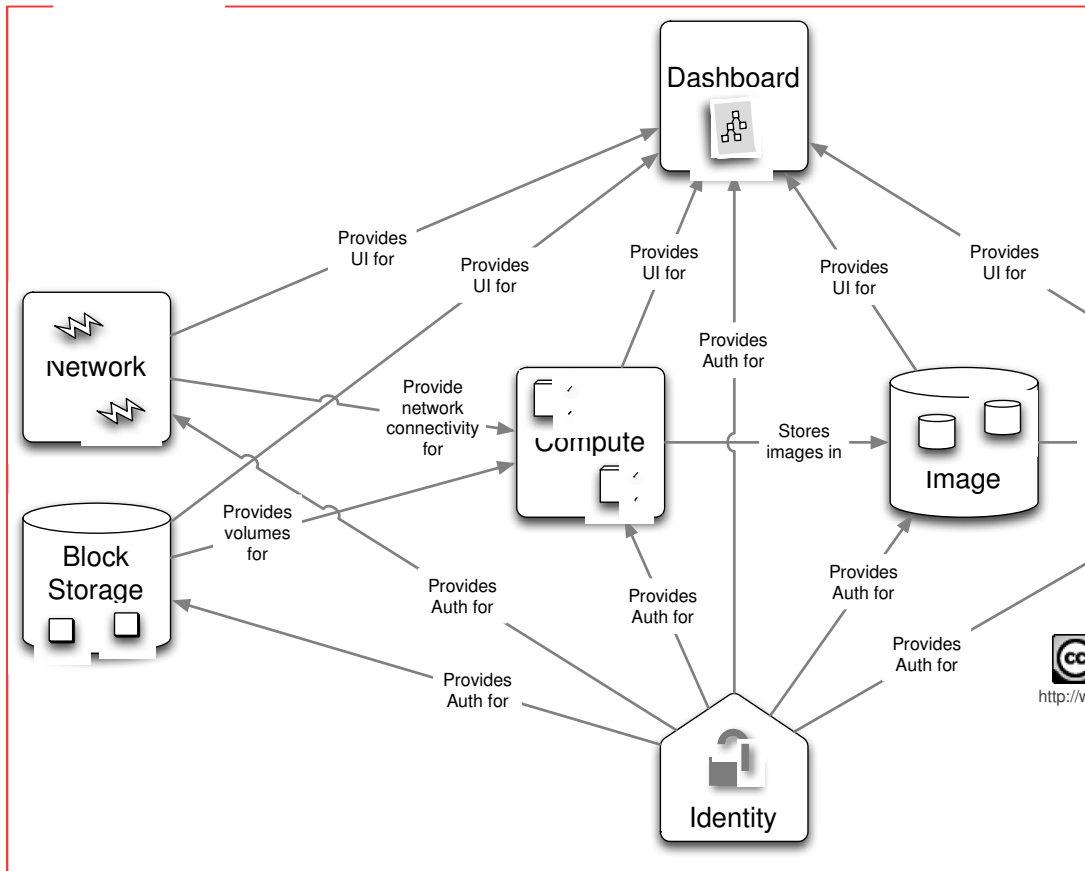

## IaaS

- Compute (Nova)**
- Block Storage (Cinder)**
- Network (Neutron)**  
(was Quantum)  
Provision and manage virtual resources
- Dashboard (Horizon)**  
Self-service portal
- Image (Glance)**  
Catalog and manage server images
- Identity (Keystone)**  
Unified authentication and authorization
- Object Storage (Swift)**  
petabytes of secure, reliable object storage

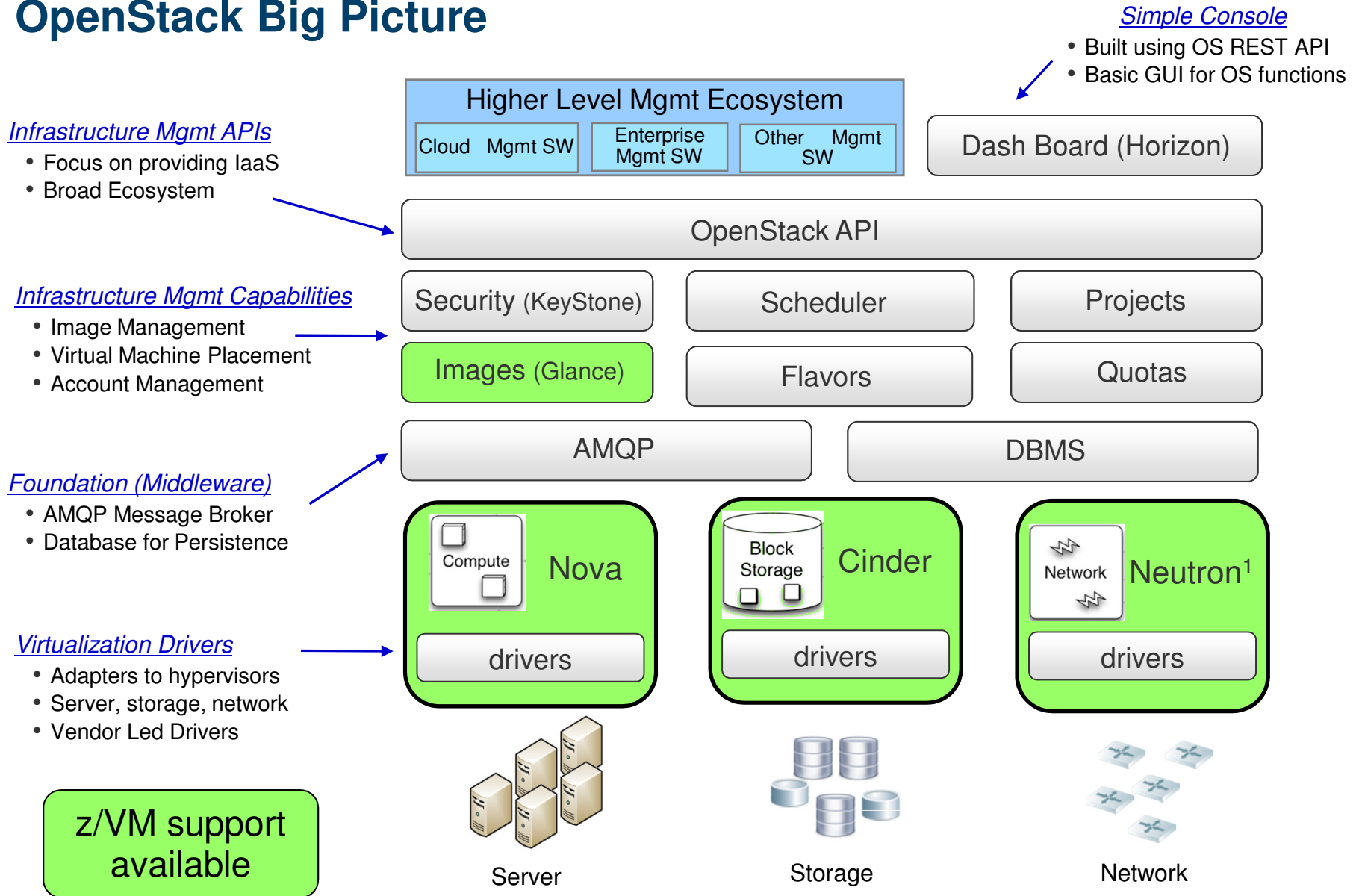

Image Source: <http://www.solinea.com/2013/04/17/openstack-summit-intro-to-openstack-architecture-grizzly-edition/>

## OpenStack Deliverables and z/VM

- OpenStack releases are every 6 months
  - Expect z/VM service and releases to open source outside the normal z/VM release cadence
  
- The framework for support of OpenStack communication is in base of z/VM 6.3
  
- Initial z/VM OpenStack enablement (part on the z/VM side) available as service in December 2013
  
- Initial introduction IBM SmartCloud technology for z/VM will be based on Havana level by incorporating code z/VM Development has released to OpenSource

# OpenStack Big Picture



<sup>1</sup> – Formerly known as Quantum.

## Examples of Supported z/VM OpenStack Features

- Provisioning virtual machines and host
  - Resize virtual machine (memory, CPU) [Nova]
  - Disk (Add SCSI disk to virtual machine) [Nova, Cinder]
  - Support for Open vSwitch [Neutron<sup>1</sup>]
  
- Automation
  - Start / Stop virtual machine [Nova]
  - Reboot Linux virtual machine [Nova]
  - Pause / Unpause virtual machine [Nova]
  - Capture / Deploy virtual machine [Nova, Glance]
  - Activate Image [Nova]
  
- Business Continuity
  - Live Guest Relocation [Nova]

<sup>1</sup> – Formerly known as Quantum.



# OpenStack Strategy



<http://openstack.org/>

**OpenStack** is a global collaboration of developers and cloud computing technologists that seek to produce a **ubiquitous Infrastructure as a Service (IaaS) open source cloud computing platform** for public and private clouds. OpenStack was founded by Rackspace Hosting and NASA jointly in July 2010. 160 companies and close to 3,000 developers.

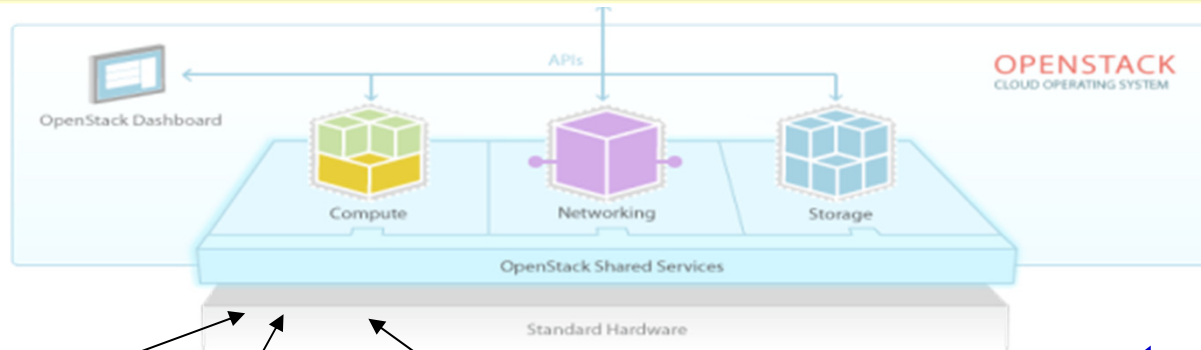
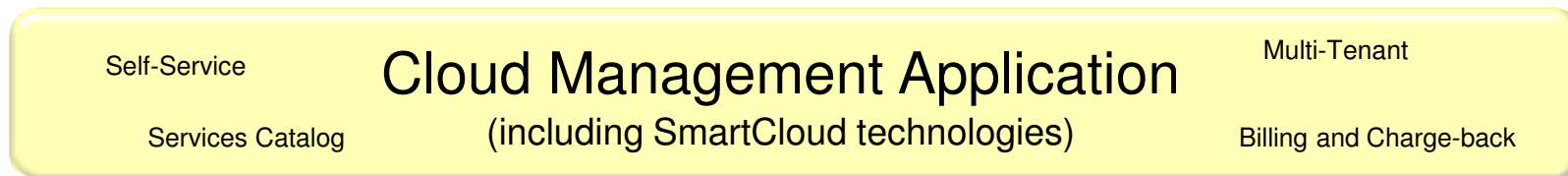

**Compute (Nova)**  
**Storage (Cinder)**  
**Network (Quantum)**  
Provision and manage virtual resources

**Direct Hypervisor Integration**  
System z support (z/VM followed by zManager) being added to OpenStack, in the same manner as other hypervisors

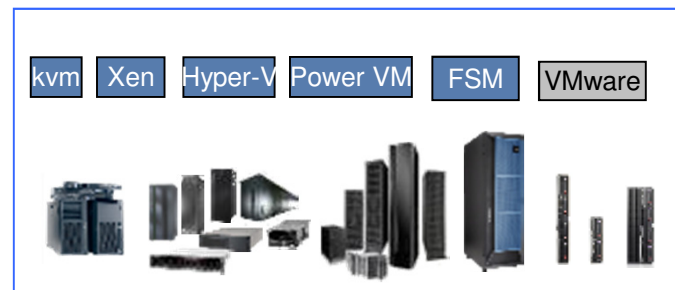
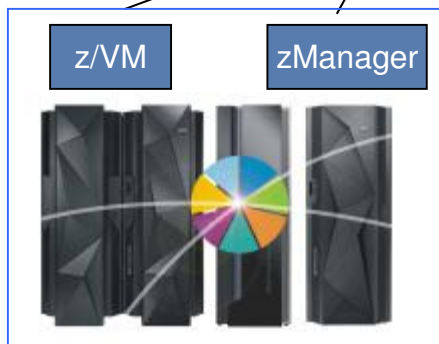

## IBM Wave for z/VM

### Helps Simplify and Automate Virtualization Management *For z/VM and Linux virtual servers*

- Automate, simplify management and monitor virtual servers and resources-all from a single dashboard
- Perform complex virtualization tasks in a fraction of the time compared to manual execution
- Provision virtual resources (Servers, Network, Storage) to accelerate the transformation to cloud infrastructure
- Supports advanced z/VM<sup>®</sup> management capabilities such as Live Guest Relocation with a few clicks
- Delegate responsibility and provide more self service capabilities to the appropriate teams

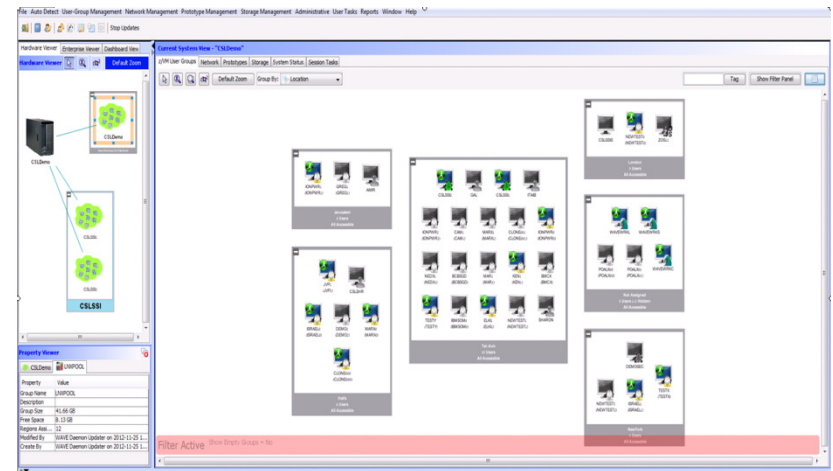

**A simple, intuitive virtualization management tool providing management, provisioning, and automation for a z/VM environment supporting Linux<sup>®</sup> virtual servers**

## Extend the Reach of Skills with IBM Wave for z/VM

### Intelligent Visualization



- Shorten the learning curve needed to manage complex environments
- Organize and simplify management of z/VM and virtual Linux servers
- View servers and storage utilization graphically; understand the status of system resources with Intelligent icons
- Reduce unnecessary steps using highly customizable views
- Graphical or tabular displays with layered drill down

### Simplified Monitoring

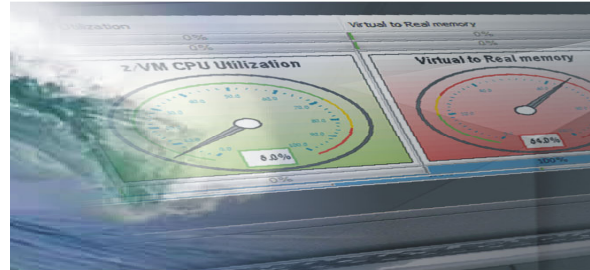

- Monitor the status of z/VM systems through an innovative interface
- Monitor performance of CPU, paging devices, spool disks and more;
- Use agentless discovery to detect an accurate view of your environment
- Use advanced filters, tagging, layout and layer selection to make monitoring and management more meaningful
- Complements IBM OMEGAMON® XE used for in-depth performance monitoring

### Unified Management



- Manage your system from a single point of control
- Assign and delegate administrative access with role based assignments
- Provision, clone, and activate virtual resources . Define and control virtual network and storage devices
- Perform management tasks such as live guest relocation
- Annotate resources for additional policy based management
- Execute complex scripts with a single mouse click

# IBM Wave Systems Management Task Example

## Add Disk Space To A Virtual Server

### Without IBM Wave

1. Find requested disk space
2. Create disk definition
3. Activate definition
4. Connect storage to virtual server
5. Mount device
6. Create a File System

### View Storage at a Glance

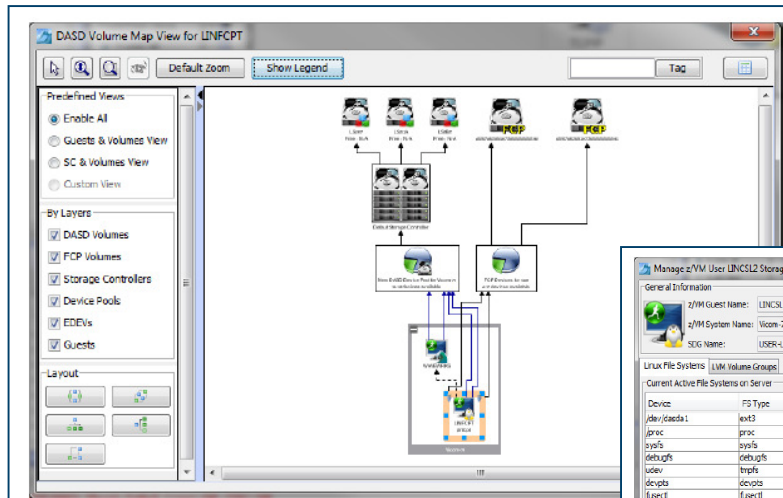

### With IBM Wave

1. Open the “Add Storage” form
2. Fill the storage capacity requested
3. Press the “Go” button

### Benefits:

- ✓ Reduce reliance on scarce skills
- ✓ Respond faster to IT customer needs
- ✓ Reduce costs
- ✓ Empower team to do more independently
- ✓ Simplify management
- ✓ Accurately depict current environment
- ✓ Reduce manual procedure errors
- ✓ Avoid problematic situations downstream

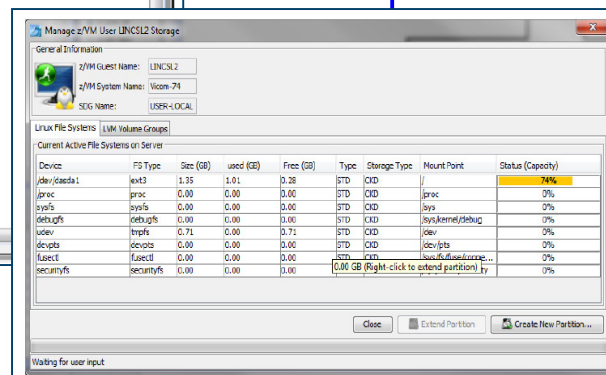

## IBM Wave for z/VM vs Operations Manager for z/VM

- IBM Wave for z/VM provides an interactive GUI interface for:
  - Provisioning of Linux guests
  - Basic performance information
  - Monitoring of virtual server resources
- Operations Manager for z/VM provides operational monitoring & automation
  - In the background
    - Monitoring of console messages for z/VM service machines and Linux guests
    - Monitoring “state” information for z/VM service machines and Linux guests
    - Monitoring spool and page space on the z/VM system
    - Automated responses to these monitors when they are triggered
      - Email
      - SNMP alerts
      - Integration with IBM Tivoli Netcool/OMNIBus enterprise alert system
      - Actions that address the problem immediately in addition to or instead of alert notificat
  - Interactive when needed
    - View and interact with live service machine and Linux guest consoles
    - View and manage spool files
- Complementary solutions
  - Use Operations Manager to monitor the IBM Wave service machines
  - User Operations Manager to automatically initiate tasks in Wave via the Wave CLI

## Cloud Computing - Based on Virtualization and Standardization

To position the various technologies in this space, we need to first understand that Cloud computing is a journey beginning with virtualization and consolidation of environments and ending with workload pattern-based deployment of IT services.

This is not always a step-wise progression. Some clients begin by optimizing their virtualization foundation for a workload, then gradually move to cloud.

Others require capabilities from the beginning and may start with entry or advanced cloud solutions.

Not all customers will want/need to get to the final step!

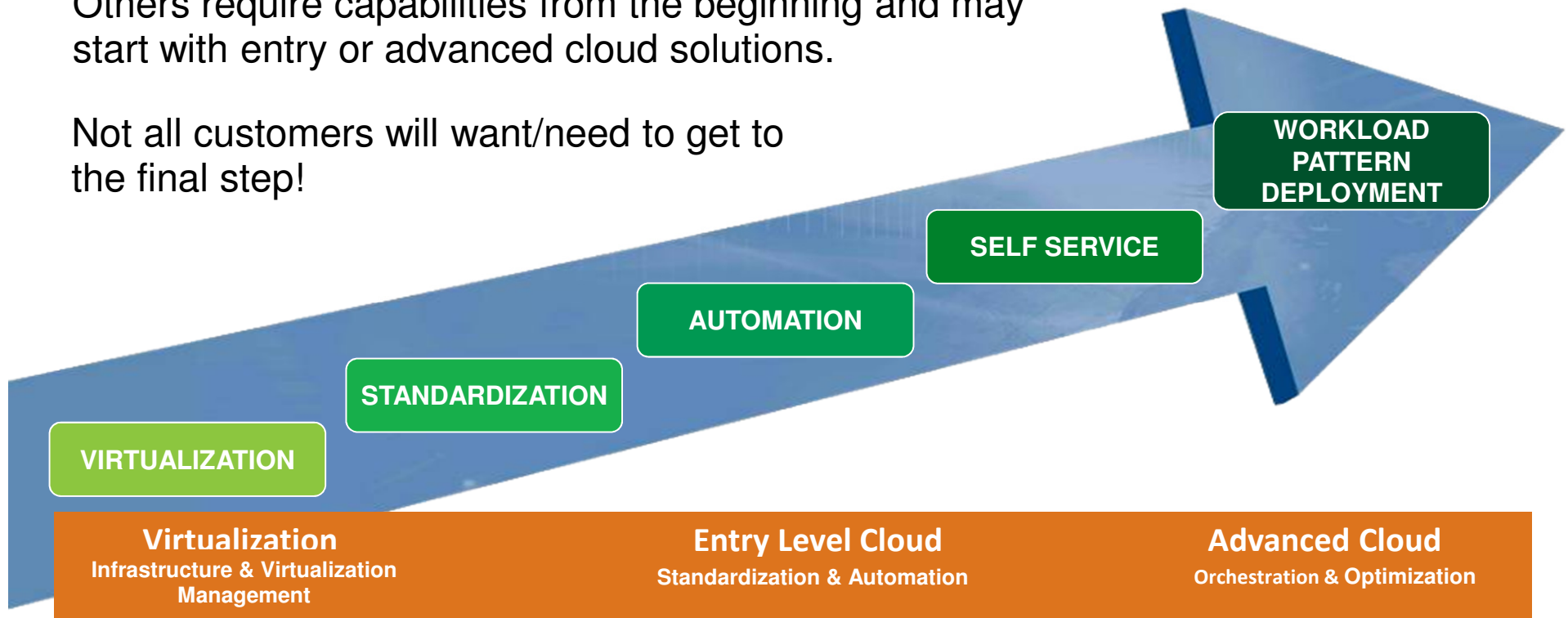

# Cloud Computing Journey

The steps in the cloud journey offer different levels of capability for the customer IT environment.

Customers can embark on their cloud journey at any step.

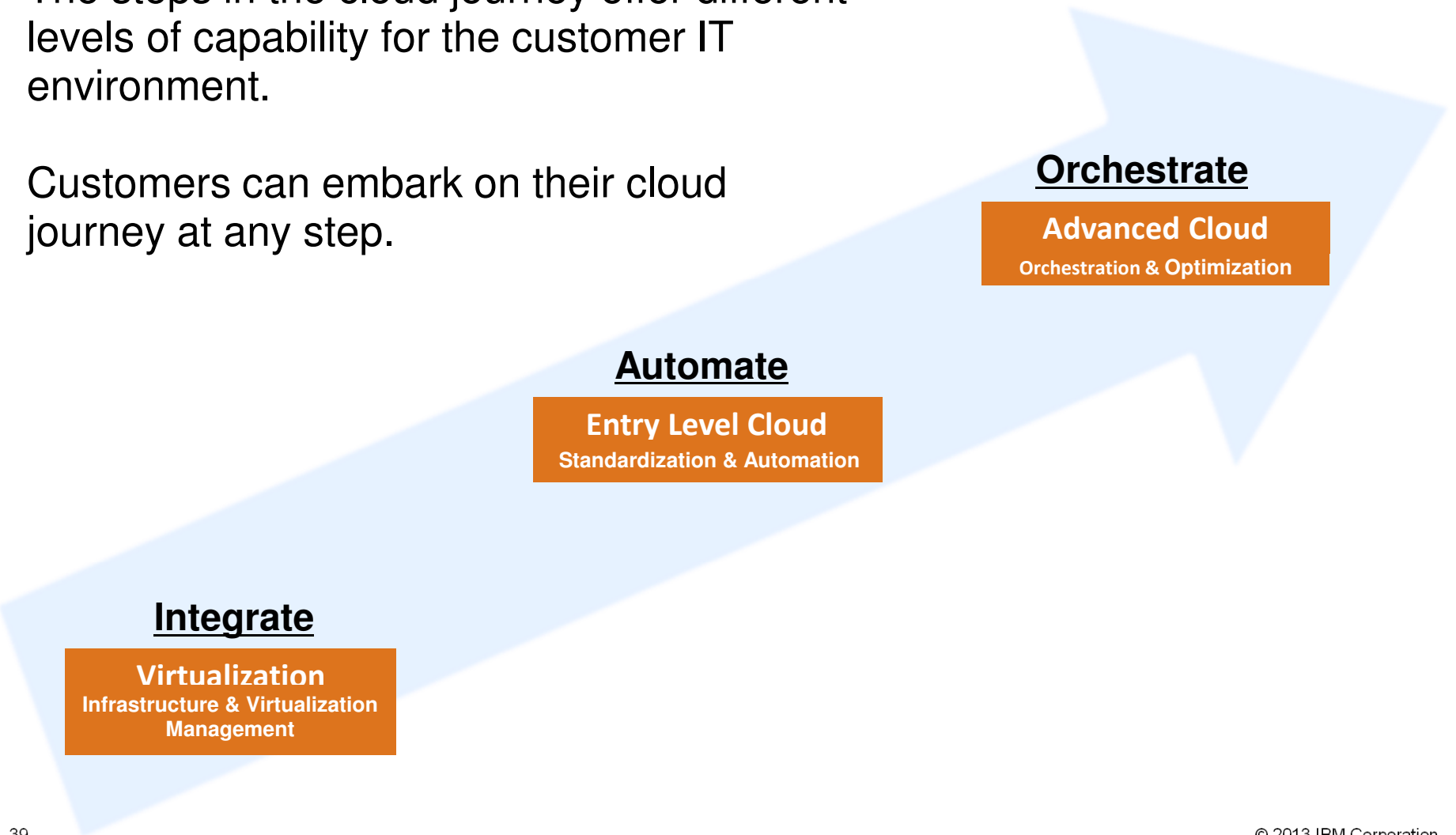

# System z Cloud Blueprint

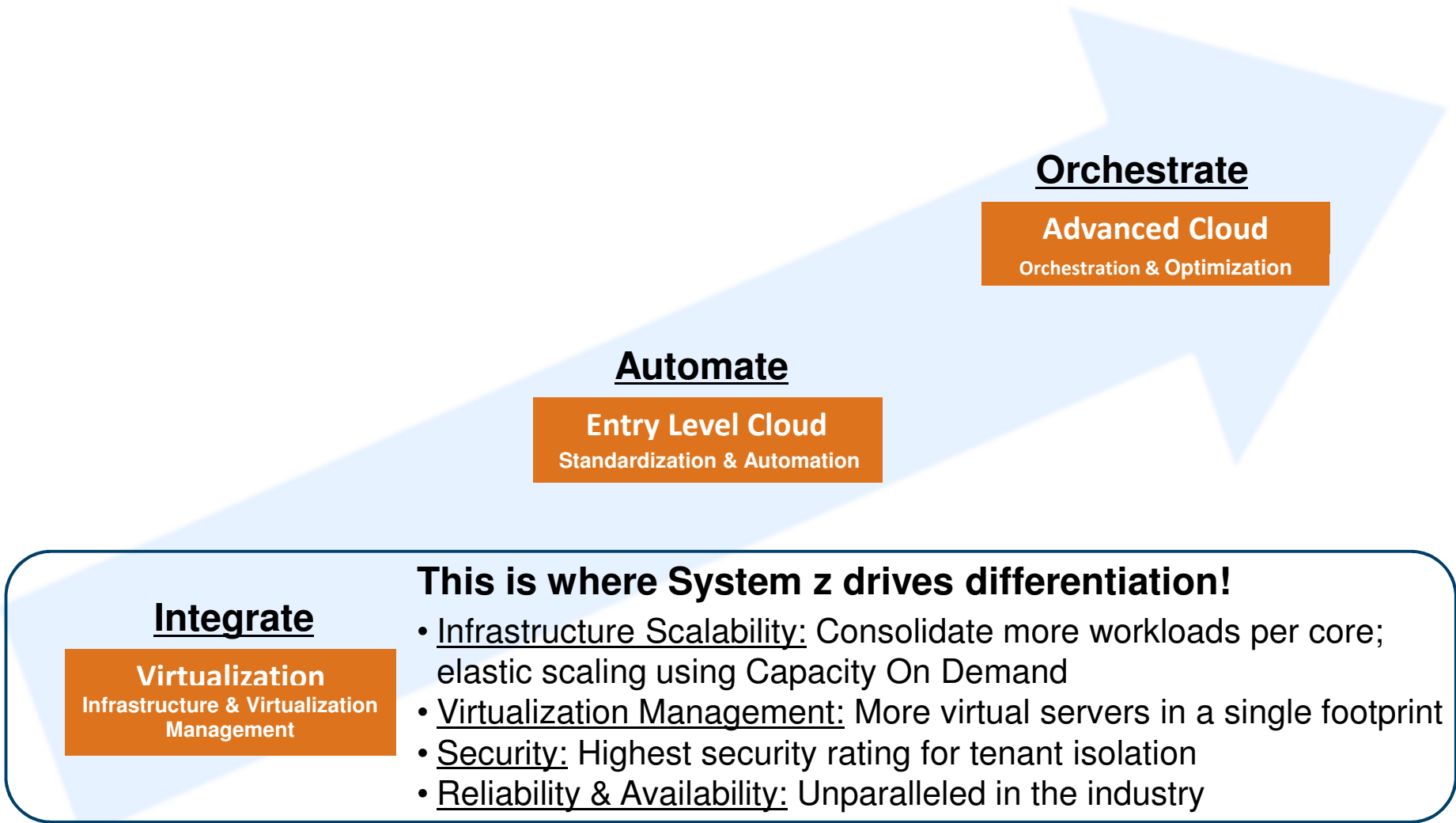



# System z Cloud Blueprint

## Orchestrate

Advanced Cloud

Orchestration & Optimization

## Automate

Entry Level Cloud

Standardization & Automation

- Customers begin to standardize their environments for faster delivery of services.
- Automation is employed to provision and deprovision virtual guest environments using a shared pool of resources.
- Some customers may choose to allow end-user self service provisioning/deprovisioning.

## Integrate

Virtualization

Infrastructure & Virtualization Management

### **This is where System z drives differentiation!**

- Infrastructure Scalability: Consolidate more workloads per core; elastic scaling using Capacity On Demand
- Virtualization Management: More virtual servers in a single footprint
- Security: Highest security rating for tenant isolation
- Reliability & Availability: Unparalleled in the industry

# System z Cloud Blueprint

## Orchestrate

### Advanced Cloud

Orchestration & Optimization

Finally, some customers will want to evolve and optimize their cloud environment to orchestrate application deployment based on reusable workload patterns in order deliver dynamic cloud services.

## Automate

### Entry Level Cloud

Standardization & Automation

- Customers begin to standardize their environments for faster delivery of services.
- Automation is employed to provision and deprovision virtual guest environments using a shared pool of resources.
- Some customers may choose to allow end-user self service provisioning/deprovisioning.

## Integrate

### Virtualization

Infrastructure & Virtualization Management

### **This is where System z drives differentiation!**

- Infrastructure Scalability: Consolidate more workloads per core; elastic scaling using Capacity On Demand
- Virtualization Management: More virtual servers in a single footprint
- Security: Highest security rating for tenant isolation
- Reliability & Availability: Unparalleled in the industry

## Virtualization and Cloud Portfolio for Linux on System z

### Virtualization Infrastructure & Virtualization Management

- **zEnterprise: zEC12, zBC12**
  - Massively scalable enterprise class server with highest levels of availability and security certification
- **z/VM 6.3**
  - Leading virtualization capability to allow for higher density of virtual servers than any other platform in a single footprint
  - Integrated OpenStack support for ubiquitous Infrastructure as a Service
- **IBM Wave**
  - Provides a graphical interface that simplifies and helps to automate the management of z/VM and Linux on System z virtual servers.
  - Completely abstracts the underlying hypervisor (z/VM) layer. Interaction is done using point-and-click and drag-and-drop gestures.
  - Can coexist with other Tivoli software such as OMEGAMON XE for z/VM and Operations Manager for z/VM
  - No upgrade path to SmartCloud suite

## Virtualization and Cloud Portfolio for Linux on System z

### Entry Level Cloud Standardization & Automation

#### ▪ **xCAT** - **E**xtreme **C**loud **A**dministration **T**oolkit

- Shipped as part of z/VM 6.3
- Scalable open source toolkit that can be used to set up and administer a rudimentary cloud environment on z/VM only, including
  - Provisioning and de-provisioning of virtual guest environments
  - Monitor physical and virtual resources
  - Provide network, storage and image management
- No upgrade path to SmartCloud suite

#### ▪ **SmartCloud Entry**

- A simple, entry level cloud management stack that can be used as a turn-key solution that cost-effectively delivers basic cloud capabilities across all supported IBM platforms.
- Based on OpenStack – IBM’s strategic code base for all cloud management software and services.
- System z support not currently available, but IBM announced a Statement of Direction:  
*“IBM intends to update IBM SmartCloud Entry to support the System z platform, by providing IBM SmartCloud Entry management software that can be installed on System z and allow SmartCloud Entry to manage heterogeneous cloud resources across System x, Power Systems, System z, PureFlex and Flex System platforms.”*

## Virtualization and Cloud Portfolio for Linux on System z

Advanced Cloud  
Orchestration & Optimization

### ▪ Cloud Ready for Linux on System z

- An image-based deployment solution for cloud service delivery and management leveraging multiple Tivoli products.
- Based on Tivoli Provisioning Manager (TPM) technology

### ▪ SmartCloud Provisioning

- Builds on functionality of SmartCloud Entry and adds middleware pattern support for workload deployment.
- Being reengineered to be based on OpenStack
- Provides z/VM support in “manage-to” environment

### ▪ SmartCloud Orchestrator

- Builds on functionality of SmartCloud Provisioning and adds runbook automation using WebSphere Business Process Manager (BPM) technology
- Based on OpenStack
- System z support not currently available, but IBM announced a Statement of Direction:  
*“IBM intends to add additional Linux on System z Cloud support built on z/VM V6.3 and OpenStack, including SmartCloud Orchestrator and SmartCloud Provisioning.”*

# Virtualization and Cloud Portfolio for Linux on System z

<b>Virtualization</b> <b>Infrastructure &amp; Virtualization Management</b>	<b>Entry Level Cloud</b> <b>Standardization &amp; Automation</b>	<b>Advanced Cloud</b> <b>Orchestration &amp; Optimization</b>
<p><b>zEnterprise: zEC12, zBC12</b></p> <ul style="list-style-type: none"> <li>• Massively scalable</li> <li>• Characterized by great economics / efficiencies</li> <li>• Highly secure / available</li> </ul> <p><b>z/VM 6.3</b></p> <ul style="list-style-type: none"> <li>• Support more virtual servers than any other platform in a single footprint</li> <li>• Integrated OpenStack support</li> </ul> <p><b>Linux on System z</b></p> <ul style="list-style-type: none"> <li>• Enterprise Linux Server</li> </ul> <p><b>IBM Wave for z/VM</b></p> <ul style="list-style-type: none"> <li>• A graphical interface tool that simplifies the management and administration of z/VM and Linux environments</li> </ul> <p><i>Differentiation</i></p>	<p><b>xCAT</b></p> <ul style="list-style-type: none"> <li>• Shipped with z/VM 6.3</li> <li>• Allows customers to set up a rudimentary cloud environment, without acquiring any additional product</li> <li>• Based on open source code</li> <li>• No upgrade path to SmartCloud suite</li> </ul> <p><b>SmartCloud Entry *</b></p> <ul style="list-style-type: none"> <li>• A simple, entry level cloud management stack</li> <li>• Based on OpenStack</li> <li>• First tier in the SmartCloud suite of cloud management products</li> </ul> <p><i>Standardization</i></p>	<p><b>Cloud Ready for Linux on System z</b></p> <ul style="list-style-type: none"> <li>• Image-based cloud service delivery with provisioning, monitoring, service catalog &amp; service desk, storage management, and HA</li> </ul> <p><b>SmartCloud Provisioning</b></p> <ul style="list-style-type: none"> <li>• Adds middleware pattern support for workload deployment, building on SCE.</li> </ul> <p><b>SmartCloud Orchestrator *</b></p> <p><b>Cloud Management Suite for System z (CMSz)</b></p> <ul style="list-style-type: none"> <li>• Builds on functionality of SmartCloud Provisioning and adds runbook automation</li> </ul> <p><i>Service Lifecycle Management</i></p>

# Virtualization and Cloud Portfolio for Linux on System z

<b>Virtualization Infrastructure &amp; Virtualization Management</b>	<b>Entry Level Cloud Standardization &amp; Automation</b>	<b>Advanced Cloud Orchestration &amp; Optimization</b>
<p><i>Differentiation</i></p>	<p><b>zPro</b></p> <ul style="list-style-type: none"><li>• Provided by Velocity Software</li><li>• Add-on feature to Velocity's zVPS product that provides performance management</li><li>• Provides golden image creation, cloning, and operational controls</li></ul> <p><i>Standardization</i></p>	<p><b>APPLogic</b></p> <ul style="list-style-type: none"><li>• Provided by CA</li><li>• Part of the 3Tera acquisition</li></ul> <p><b>Moab</b></p> <ul style="list-style-type: none"><li>• Provided by Adaptive Computing</li><li>• Provides a policy based cloud management based on xCAT REST APIs</li></ul> <p><i>Service Lifecycle Management</i></p>

## IBM Cloud Management Suite for System z V1.1

- Benefits:
  - Quickly and easily provision a workload on System z
  - Self service portal running on distributed system
  - Monitor health of cloud environment
  - Linux server backup
  - Integration of various key management components
  
- Components include:
  - IBM Smart Cloud Orchestrator
  - OMEGAMON XE on z/VM and Linux
  - Tivoli Storage Manager Extended Edition
  
- Know at times as “CMSz”
  
- Requires z/VM 6.3 with appropriate service
  
- Dates:
  - Announced February 25, 2014
  - Available March 14, 2014



## Automation

- Operations Manager for z/VM
  - Priced Product
  - Facilitates automated operations
  - Monitor, view, and interact with consoles without logging on to service machines or Linux guests
  - Take actions based on service machine console messages and other system events
  - Schedule events for immediate execution or on a regular schedule
  - Interaction with OMEGAMON XE
  
- WAKEUP Utility
  - Part of z/VM
  - Rudimentary function for basic scheduling
  
- IBM Wave for z/VM
  
- ISV Solutions exist

## Monitoring

- Operations Manager for z/VM
  - Priced Product
  - Facilitates automated operations
  - Monitor, view, and interact with consoles without logging on to service machines or Linux guests
  - Monitoring and Management of virtual machines, spool files, and error messages
  - Take actions based on service machine console messages and other system events
  - Schedule events for immediate execution or on a regular schedule
  - Interaction with OMEGAMON XE
  
- Programmable Operator (PROP)
  - Part of z/VM
  - Rudimentary function for monitoring
  
- ISV solutions exist

## Business Continuity

- Backup and Restore Manager for z/VM
  - Priced Product
  - Backup and restore file level data for CMS minidisks and Shared File System
  - Backup and restore images of Linux guests and/or z/VM volumes
    - Use Tivoli Storage Manager for file level backup and restore of Linux data
  - Compression
  - Exit available for encryption
  
- GDPS® Offering
  - Priced Offering
  
- Live Guest Relocation
  - Part of z/VM
  - Address planned outages

## Data Management

- Backup and Restore Manager for z/VM
  - Priced Product
  - Backup and restore file level data for CMS minidisks and Shared File System
  - Backup and restore images of Linux guests and/or z/VM volumes
    - Use Tivoli Storage Manager for file level backup and restore of Linux data
- Tape Manager for z/VM
  - Priced Product
  - Manage tapes: retention, access control, data security erase
  - Manage devices: share with other z/VM and non-z/VM systems
  - Manage mount requests for ATL, VTS, and manual mount devices
    - Supports IBM and Oracle STK libraries
- Archive Manager for z/VM
  - Priced Product
  - Users and administrators manage disk space more efficiently and effectively
  - Archive infrequently used or large files to tape or other disk
- Other Options
  - Rudimentary with DDR or from z/OS
- ISV solutions exist

## Accounting

- CP System Service \*ACCOUNT – interface to accounting information (processor, I/O, memory, ... resources)
- RETRIEVE – VM utility that captures accounting records
- ACCOUNT – VM utility to produce reports from accounting records. Very simple.
- Other Vendor products exist for processing records.
- Do It Yourself
- IBM Tivoli Usage and Accounting Manager (ITUAM)
- Overlap with performance management
  - Some customers are using performance data for charge back

## Security

- CP System Service \*RPI – allows interaction with and ESM (External Security Manager)
  
- Base and extensions for
  - Virtual machine authentication
  - Virtual machine authorization
  - Auditing of violations
  
- RACF for VM is a priced feature that is pre-installed on the base system.
  
- zSecure™ Manager for RACF z/VM
  - Automate complex, time consuming z/VM security management tasks
  - Quickly identify and prevent problems in RACF
  - Create comprehensive audit trails
  
- ISV External Security Managers (ESMs)

## Performance

- Performance Toolkit for z/VM
  - Priced feature of z/VM that is pre-installed
  - Basic realtime monitoring and report generation
- OMEGAMON® XE on z/VM and Linux
  - Priced Product
  - Performance monitoring of z/VM and Linux guests
  - Part of the OMEGAMON and IBM Tivoli Monitoring infrastructure, including Tivoli Enterprise Portal
  - Uses IBM Performance Toolkit for VM as its data source
  - Optionally uses Linux agent in virtual machines
- IBM Wave for z/VM
  - Very small subset based on Performance Toolkit data
- IBM Tivoli Decision Support (TDS)
  - Capacity Planning
- ISV Solutions
- VM Resource Manager
  - Part of z/VM product
  - Like Workload Manager, but less function and less effective

## Provisioning

- xCAT
  - Integrated in base of z/VM 6.3
  
- Other Tivoli products
  
- IBM Wave for z/VM
  
- ISV Solutions
  
- IBM SmartCloud Technology products



## Summary

- Systems Management is multi-faceted
  - What Systems?
  - What Management?
  - Self Integrate vs. Product Solutions
  
- Must address all the disciplines to be enterprise-ready
  
- OpenStack Enablement is Strategic
  
- Continue to enhance various capabilities of z/VM to support the ecosystem
  
- Expect changes outside of the standard cadence of z/VM releases
  - SmartCloud Technology products
  - IBM Wave for z/VM
  - ISV solutions
  - z/VM SPEs to facilitate the above
  
- <http://www.vm.ibm.com/sysman/>



# Additional OpenStack Information

# Deployments consist of projects interfacing over public APIs, with each project composed of multiple services interfacing via private APIs over RPC

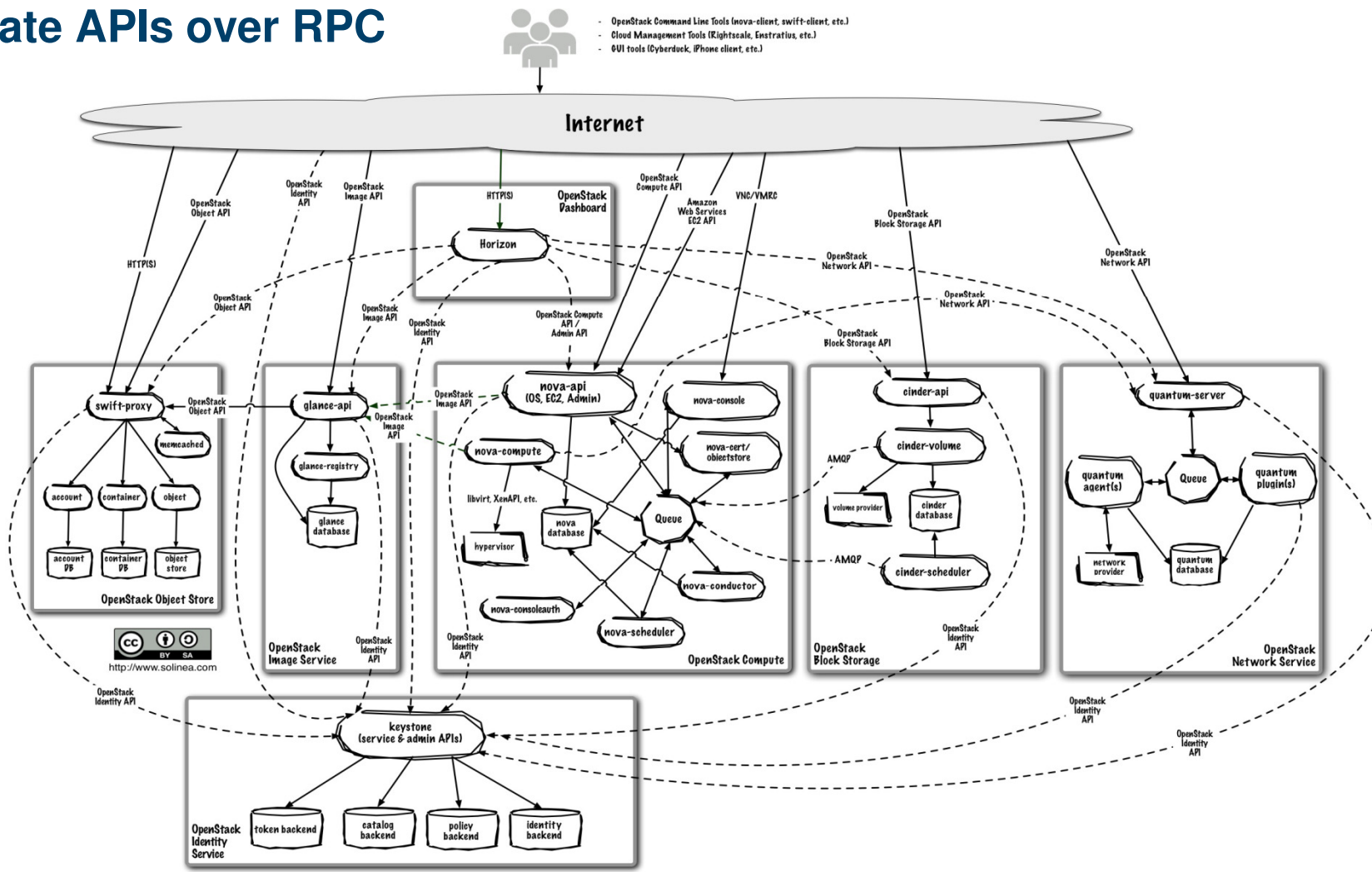

# Compute (Nova) is a horizontally scalable offering on-demand compute resources by provisioning and managing

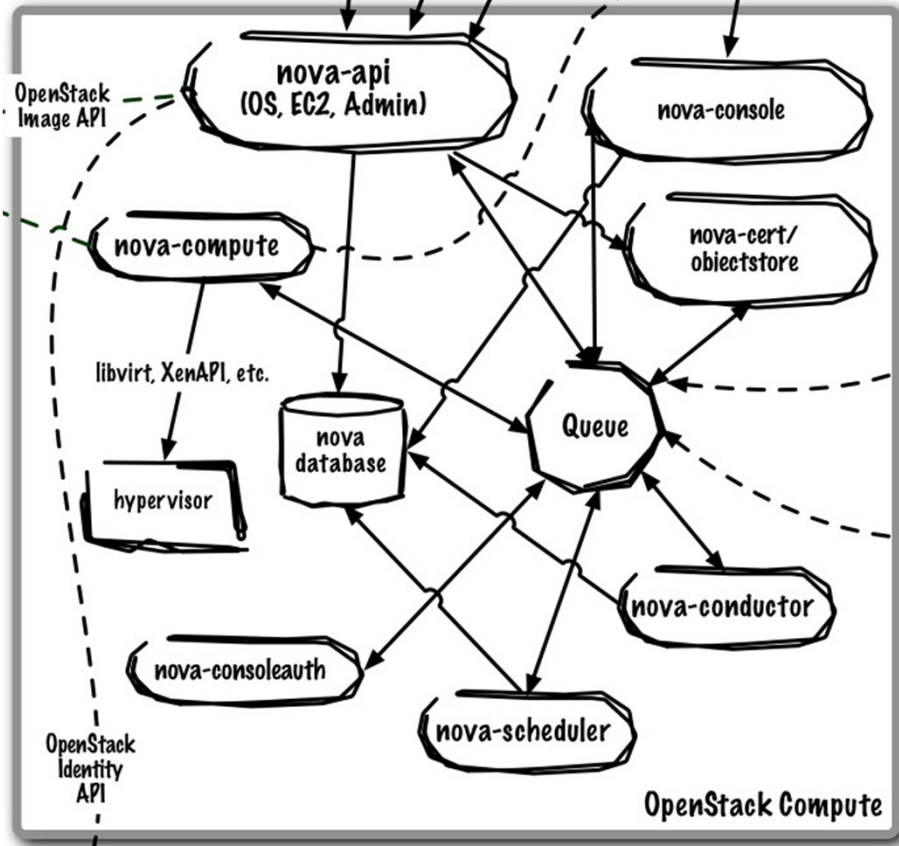

### Core Use Case:

- Provision and manage virtualized compute resources (CPU, memory, disk, network)

### Key Capabilities:

- REST-based APIs with rate limiting and authentication
- Manage Local Area Networks (LAN)
- Live migration of guests
- VM management (Instance)
  - Run, reboot, suspend, resize, terminate instances
- Floating IP addresses
- Security Groups
- RBAC with Projects & Quotas
- Manage to KVM, Xen (XenServer, Xen Cloud Platform), LXC, VMware vSphere 4.1+, Hyper-V, Bare Metal, PowerVM (limited)

# Database and Queue are central to the Nova control plane

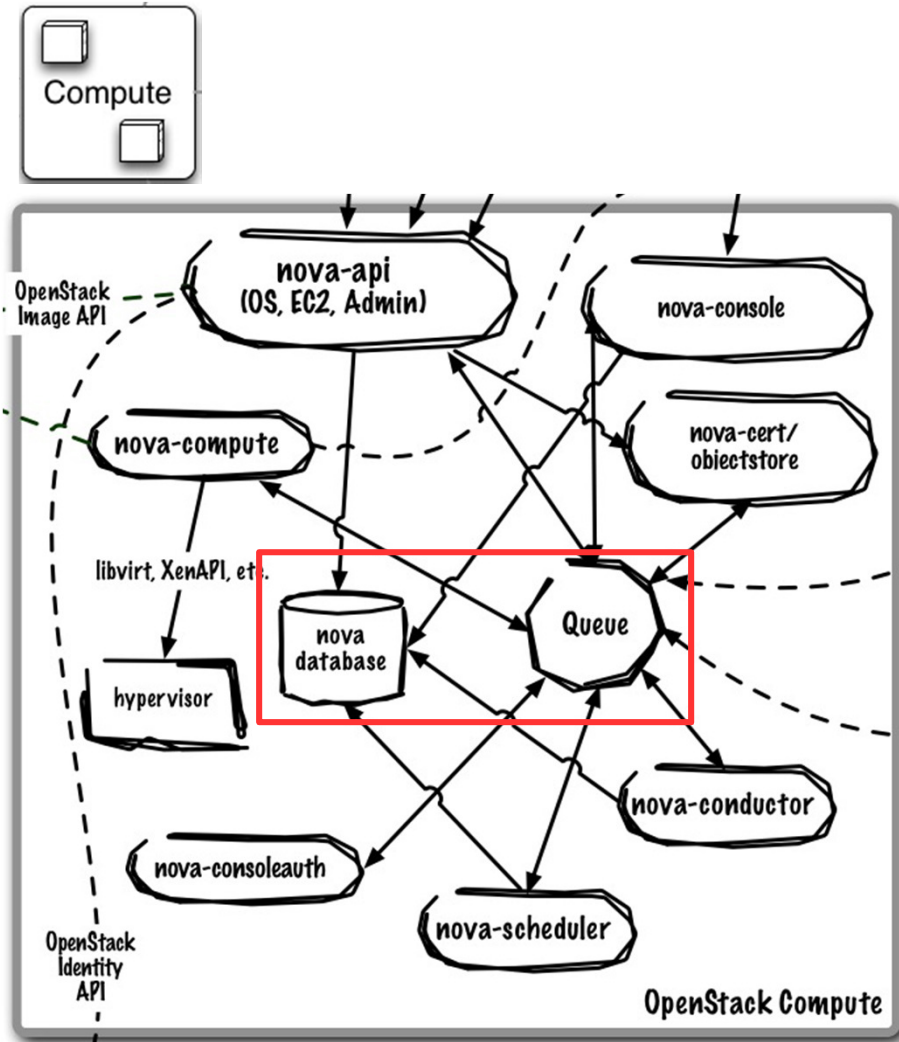

**Core Use Case:**

- Queue provides RPC messaging between services
- Database provides data persistence

**Runs As:** Controller Service

**Deployment Considerations:**

- Use DB and Queue clustering/HA methods
- ZeroMQ implementation available to decentralize queue

**Key Capabilities:**

- Community uses RabbitMQ as default queue, MySQL DB (IBM uses Apache Qpid and DB2)
- Single “cell” (1 Queue, 1 Database) typically scales from 500 – 1000 physical machines
  - Cells can be rolled up to support larger deployments
- Communications route through queue
  - API requests are validated and placed on queue
  - Workers listen to queues based on role or role + hostname
  - Responses are dispatched back through queue

# nova-compute manages individual hypervisors and compute nodes

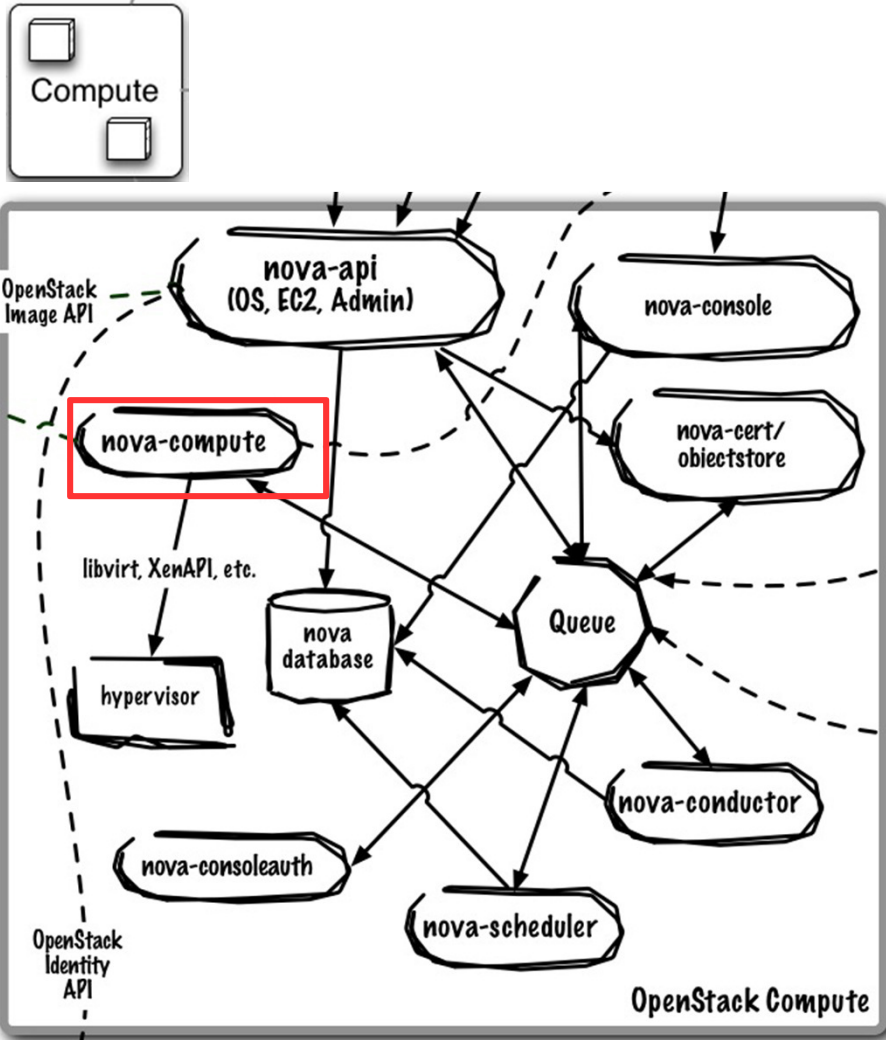

### Core Use Case:

- Manage all interactions with single hypervisor control point

### Runs As: Distributed Service

### Deployment Considerations:

- Many nova-compute instances exist in the environment to ensure compute provisioning is always available
- Single nova-compute is not HA, manage single hypervisor to minimize failure domain
- No direct database access is required

### Key Capabilities:

- Create and manage virtual machines on hypervisor
- Attach networks and volumes to physical host (iSCSI, FC), expose to guest virtual machines
- Implementation point for security groups defining firewall rules for guest network traffic
- Uses plug-in model to manage to different hypervisors

# nova-scheduler allocates virtual resources to compute nodes

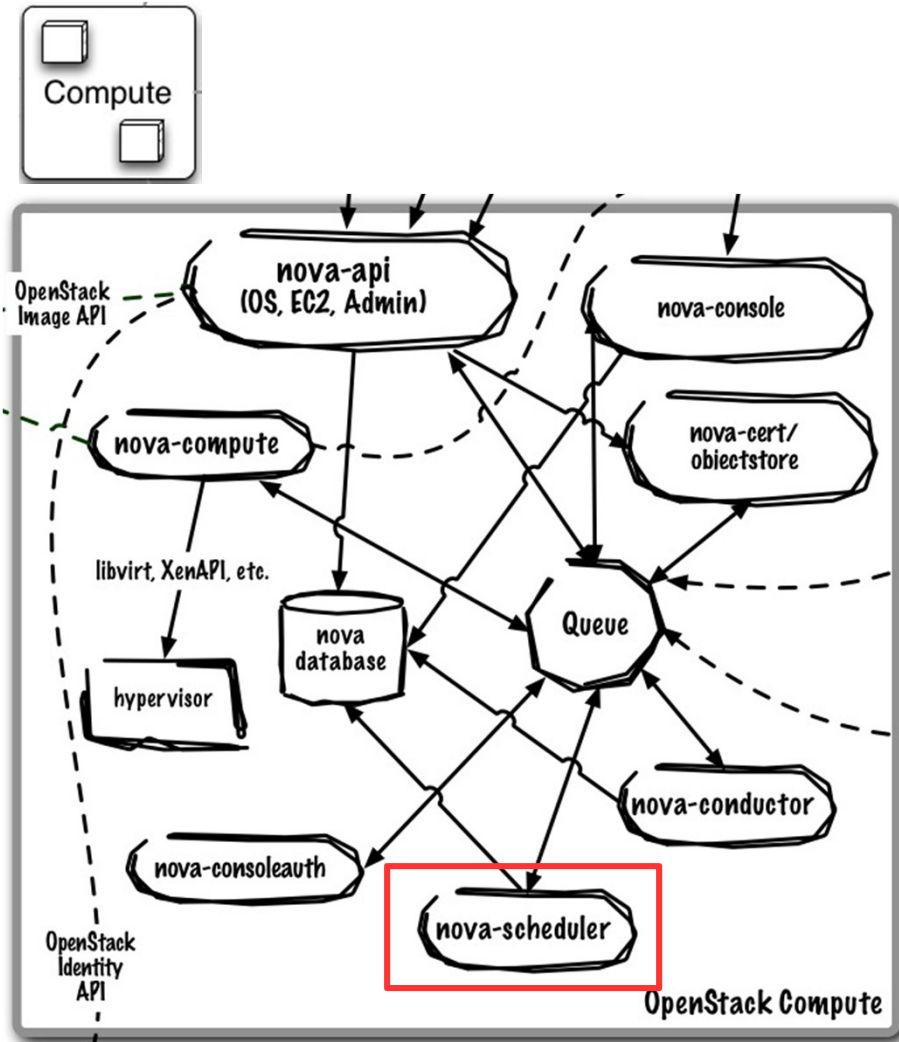

**Core Use Case:**

- Selects compute node to run virtual machine on

**Runs As:** Controller Service

**Deployment Considerations:**

- Default scheduler is horizontally scalable
- For other schedulers (e.g. Platform EGO), follow their specific best practice

**Key Capabilities:**

- Default scheduler is allocation-based using a series of filters to reduce set of applicable hosts and uses costing functions to provide weight
- Platform EGO adds utilization-based scheduling to default allocation based

# nova-api supports multiple API implementations and is the entry point into the cloud

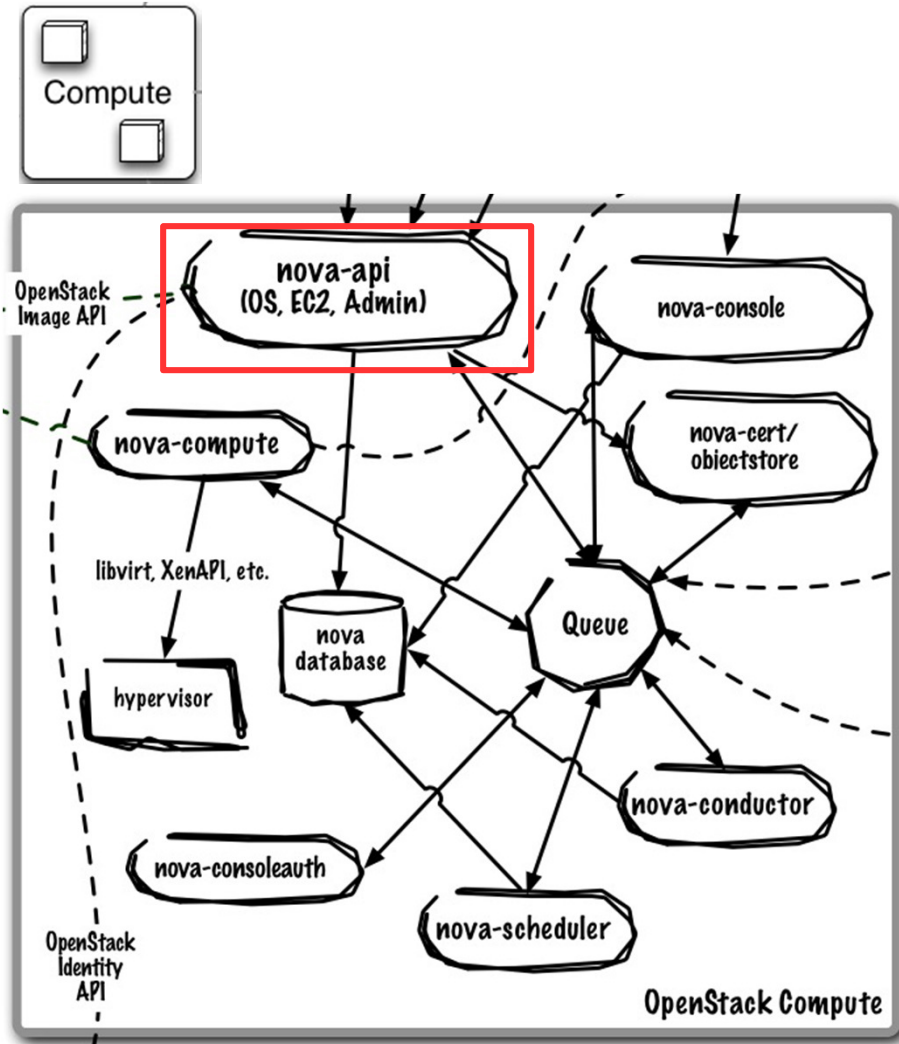

**Core Use Case:**

- Accept, validate, authenticate, and distribute incoming REST API requests

**Runs As:** Controller Service

**Deployment Considerations:**

- Horizontally scalable, start many instances
- Front with load-balancer to present as single endpoint

**Key Capabilities:**

- APIs supported
  - OpenStack Compute API
  - EC2 API (subset)
- Robust extensions mechanism to add new capabilities



# nova-conductor manages database interactions on behalf of compute nodes

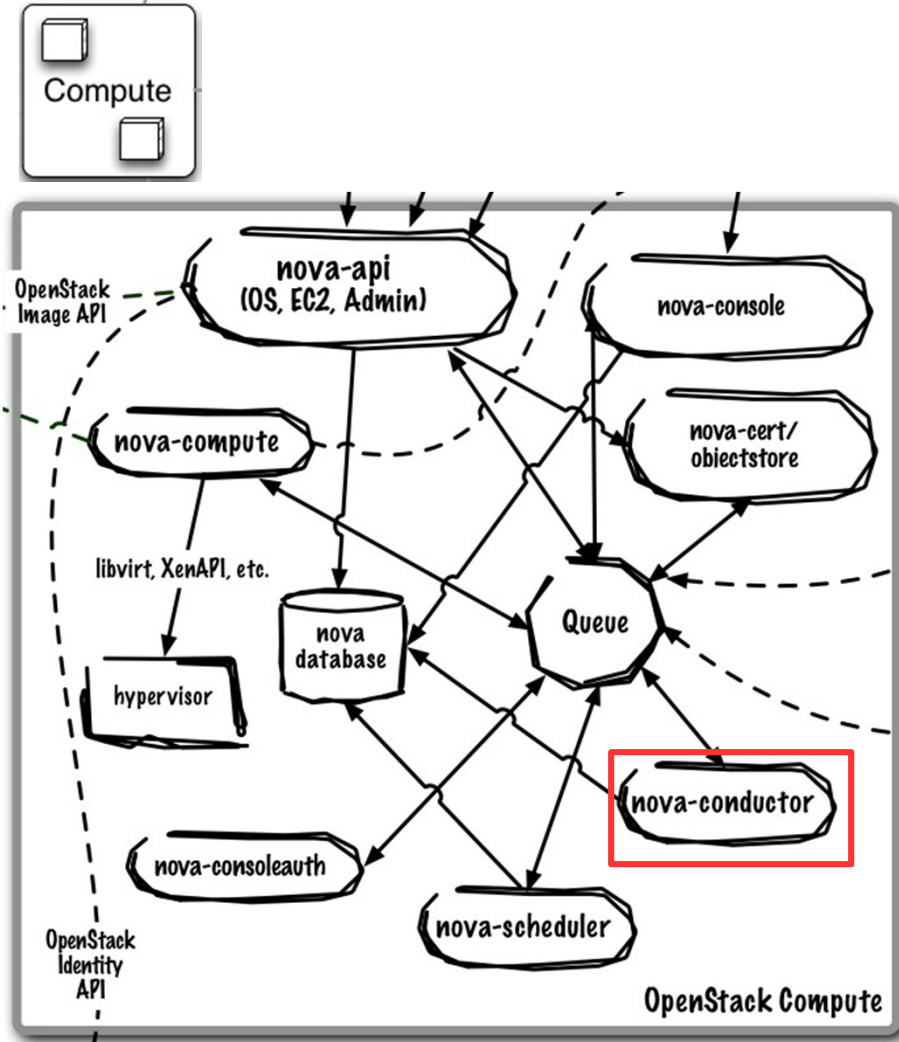

**Core Use Case:**

- Handles all database requests for nova-compute service

**Runs As:** Controller Service

**Deployment Considerations:**

- Horizontally scalable, start many instances

**Key Capabilities:**

- Talks directly to database on behalf of compute nodes

## Network (Quantum) is a pluggable, scalable and API-driven system for managing networks and IP addresses

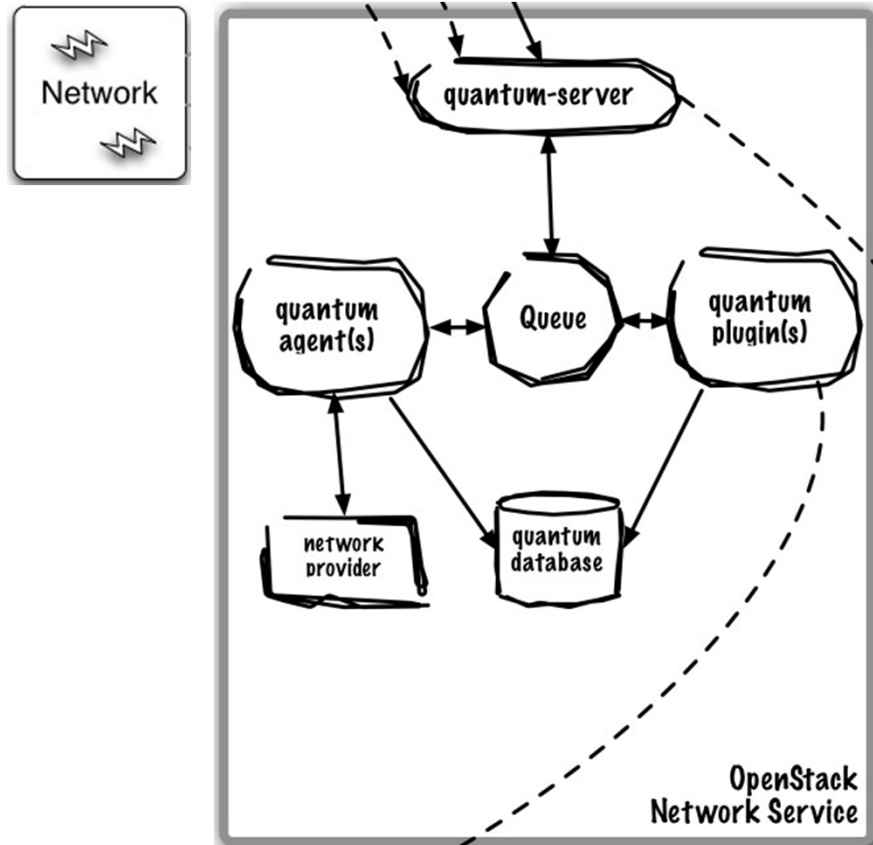

### Core Use Cases:

- Provision and manage virtualized network resources (networks, ports, attachments)

### Key Capabilities:

- Flexible networking models to suit the needs of different applications or user groups
- Create/delete tenant-specific L2 networks
- Attach / Detach host to network
- L3 support (dedicated static and DHCP, Floating IPs, DHCP, Routing)
- L4-7 Support (Load Balancers)
- Extension framework enabling deploy and management of additional network services: intrusion detection systems (IDS), load balancing, firewalls and virtual private networks (VPN)
- Support for
  - OpenFlow (Big Switch, Floodlight, NEC controllers)
  - Numerous SDN and network virtualization providers (e.g Niciria, Midokura, Plum Grid, Brocade, Mellanox)
  - OpenVswitch
  - Cisco Nexus

## Database and Queue are central to the Quantum control plane

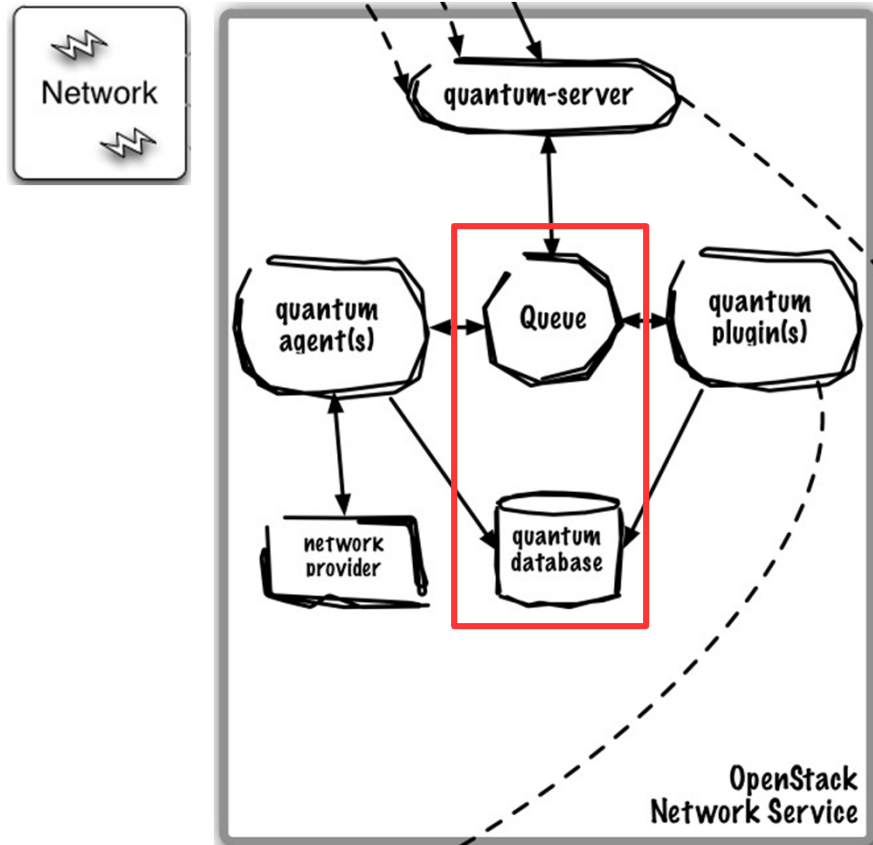

### Core Use Case:

- Queue provides RPC messaging between services
- Database provides data persistence

### Runs As: Controller Service

### Deployment Considerations:

- Use DB and Queue clustering/HA methods
- ZeroMQ implementation available to decentralize queue
- Can use same Queue as Nova

### Key Capabilities:

- Community uses RabbitMQ as default queue, MySQL DB (IBM uses Apache Qpid and DB2)

## quantum-server implements the OpenStack Network API

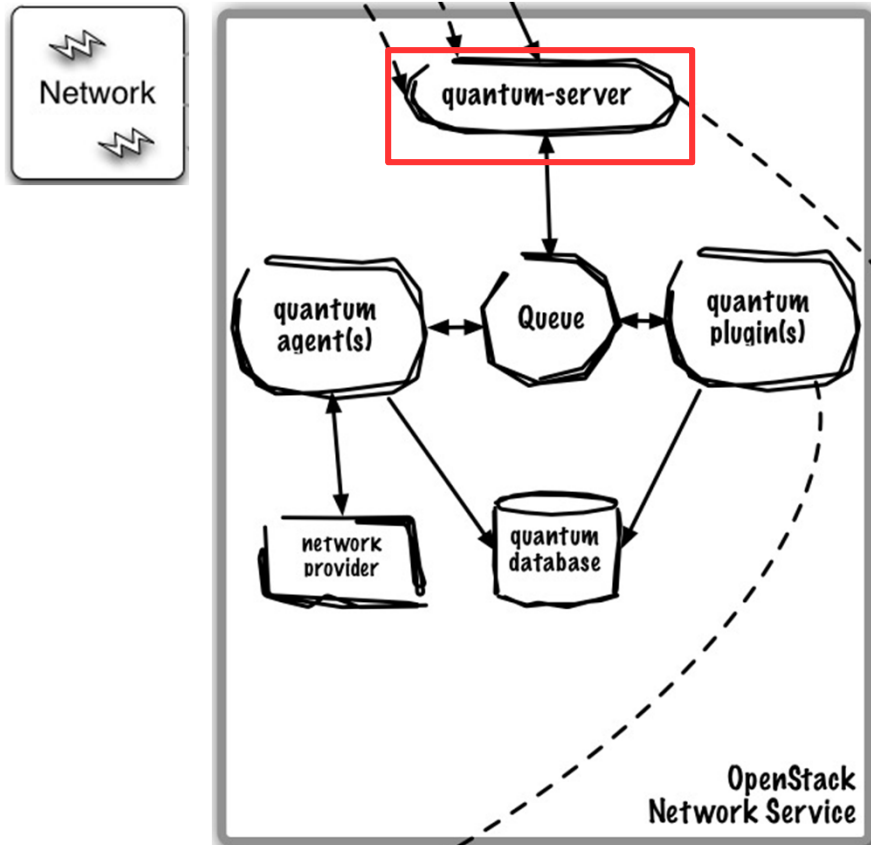

### Core Use Case:

- Accept, validate, authenticate, and distribute incoming REST API requests

### Runs As: Controller Service

### Deployment Considerations:

- Use active/passive or active/active for HA using Linux HA methods (e.g. corosync)

### Key Capabilities:

- Requires access to a database for persistent storage
- Passes user requests to the configured OpenStack Networking plug-in for additional processing
- Relies on the OpenStack Identity Project (Keystone) for authentication and authorization of all API request.

# Quantum uses an agent model to add additional functionality to a deployment

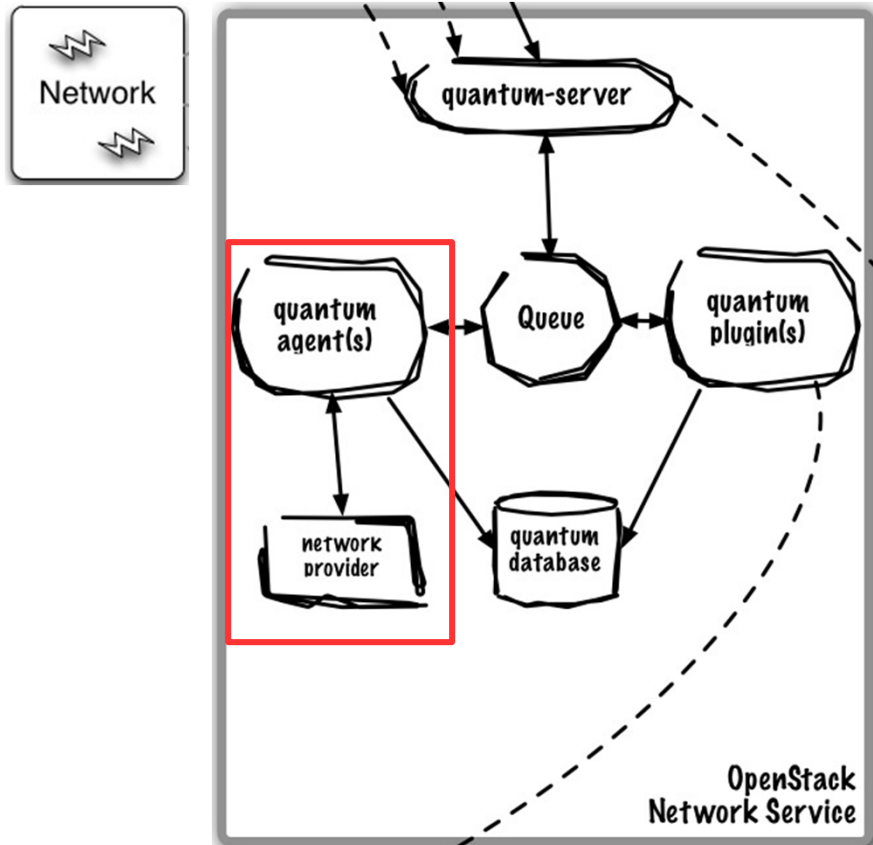

**Core Use Case:**

- plugin-agent: runs alongside nova-compute to manage physical host network connectivity
- dhcp-agent: provides DHCP to tenant networks
- l3-agent: provides L3/NAT forwarding for external network access

**Runs As:** Distributed Service (plugin-agent) or Controller Service (dhcp-agent, l3-agent)

**HA:**

- plugin-agent: same as nova-compute, single instance is not HA, minimize failure domain
- dhcp-agent, l3-agent: running many ensures availability to provision new, can use active/passive or active/active for HA of provisioned node.

**Key Capabilities:**

- plugin-agent: runs alongside nova-compute to manage physical host network connectivity
- dhcp-agent: provides DHCP to tenant networks
- l3-agent: provides L3/NAT forwarding for external network access

# Quantum plugins are vendor or technology-specific plugins that map virtual network topology onto infrastructure

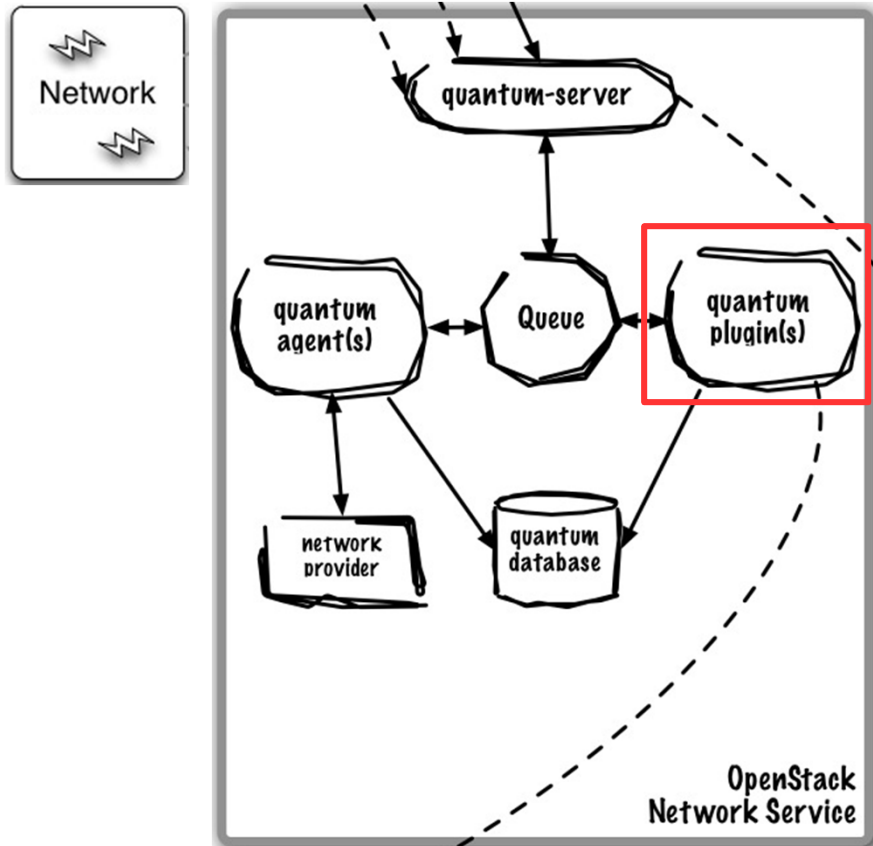

**Core Use Case:**

- Map virtual network topology onto infrastructure

**Runs As:** Controller Service

**HA:**

- Dependent on implementation

**Key Capabilities:**

- Uses plug-in model to support vendor-specific or technology-specific implementation that translates virtual networks to physical network

## Storage (Cinder) exposes block devices to be connected to compute instances for expanded storage, better performance and enterprise storage platform integration

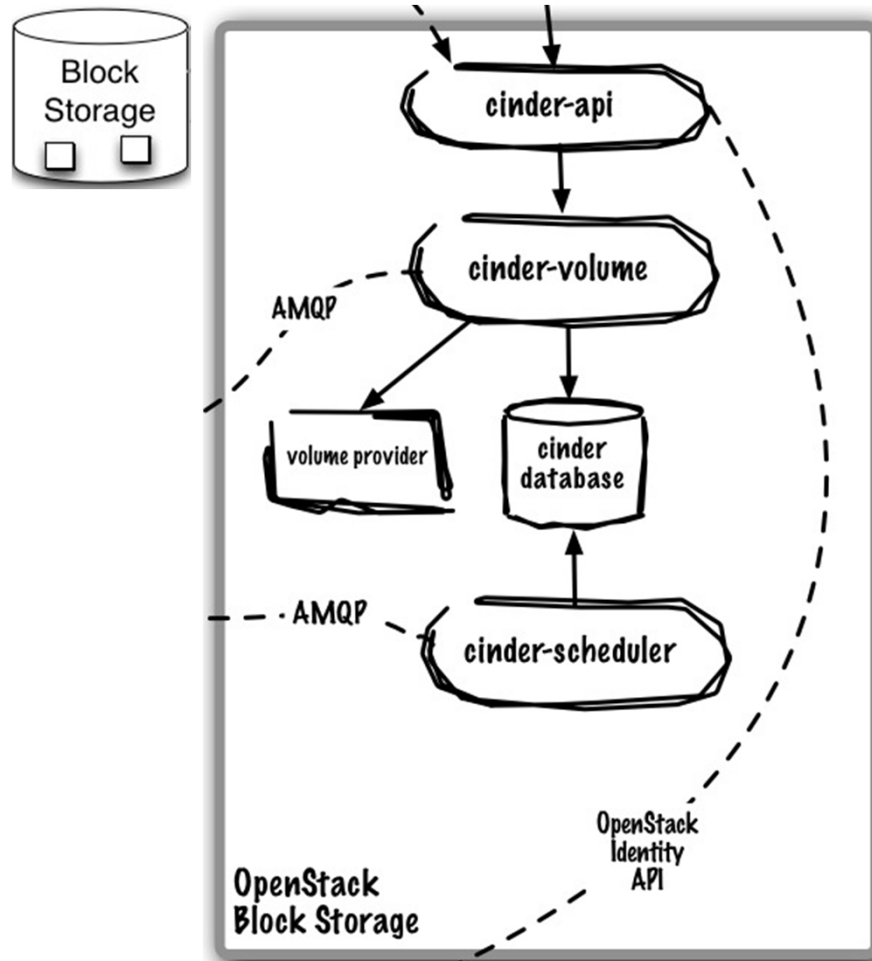

### Core Use Cases:

- Provision and manage lifecycle of volumes and their exposure for attachment

### Key Capabilities:

- Persistent block level storage devices for use with OpenStack compute instance
- Manage the creation, attaching and detaching of the block devices to servers
- Support for booting virtual machines from Cinder-backed storage
- Snapshot and restore functionality
- Supports following
  - LVM-backed volumes (iSCSI)
  - XIV (iSCSI)
  - SVC (iSCSI and Fiber Channel)
  - NetApp (iSCSI and NFS)
  - EMC (iSCSI)
  - HP/Lefthand (iSCSI)
  - RADOS block devices (e.g. Ceph distributed file system)
 (full list at Cinder Support Matrix)

## Database and the Queue are the core of Cinder's control plane

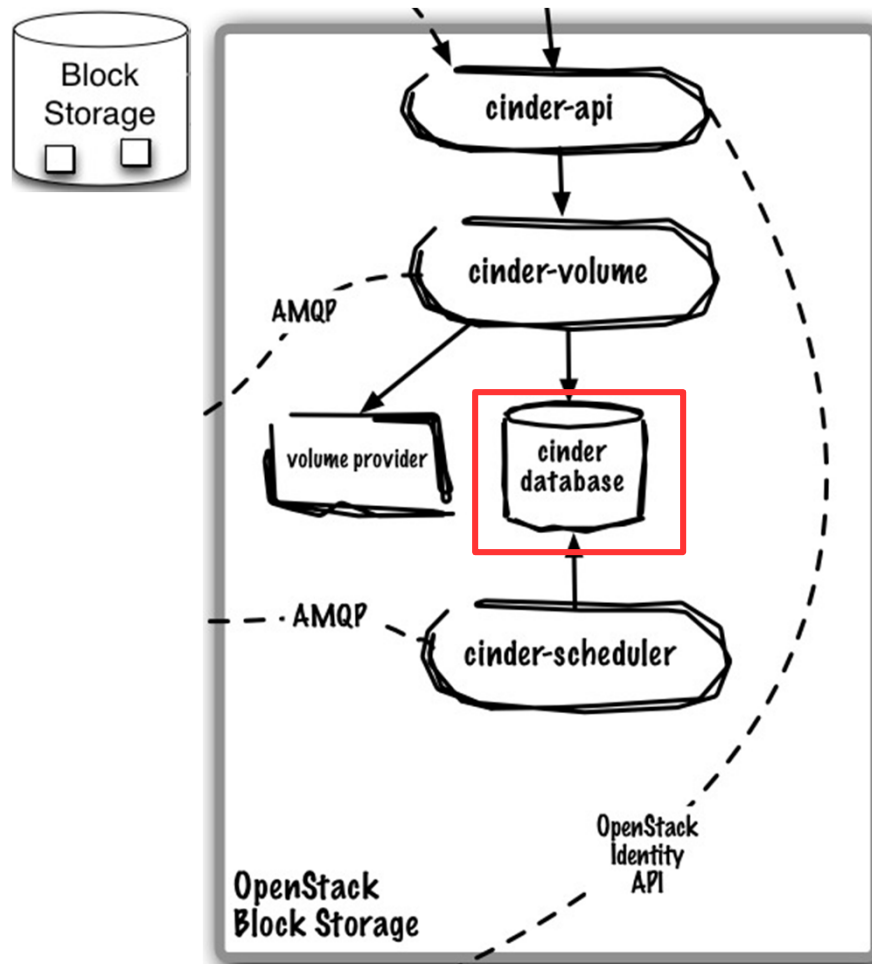

### Core Use Case:

- Queue provides RPC messaging between services
- Database provides data persistence

### Runs As: Controller Service

### Deployment Considerations:

- Use DB and Queue clustering/HA methods
- ZeroMQ implementation available to decentralize queue
- Can use same queue/database as Nova

### Key Capabilities:

- Community uses RabbitMQ as default queue, MySQL DB (IBM uses Apache Qpid and DB2)



## cinder-api is the entry point to OpenStack Volume Service

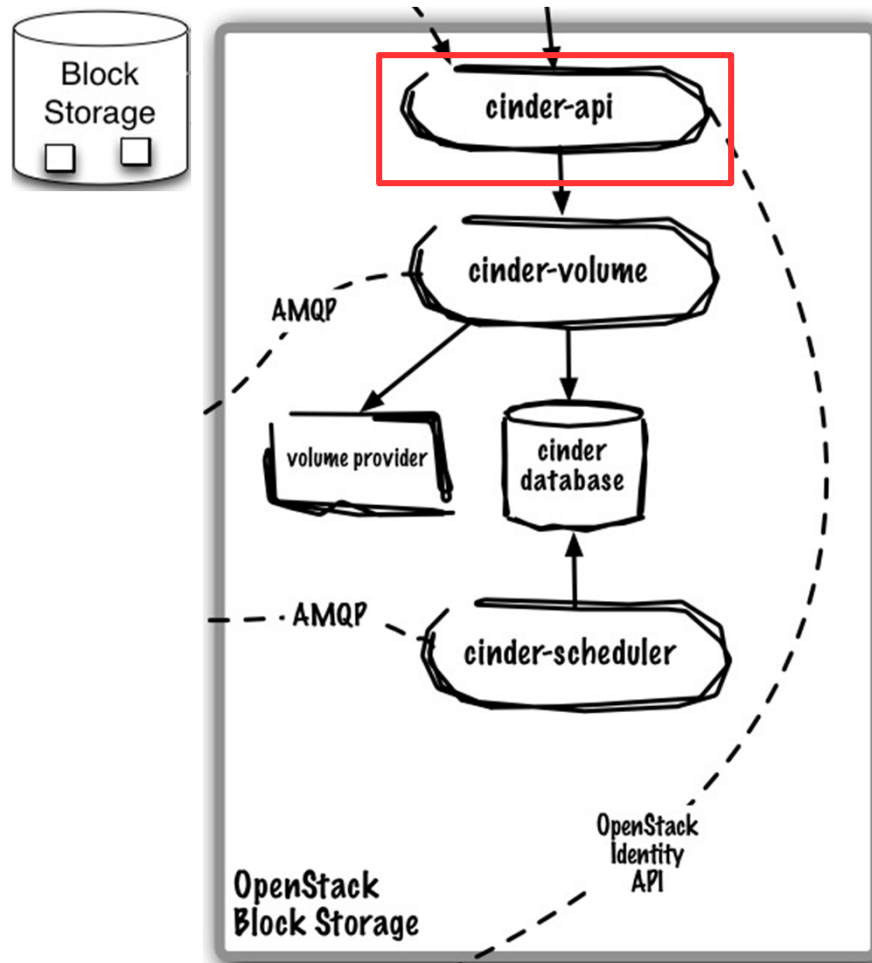

### Core Use Case:

- Accept, validate, authenticate, and distribute incoming REST API requests

### Runs As: Controller Service

### Deployment Considerations:

- Horizontally scalable, start many instances
- Front with load-balancer to present as single endpoint

### Key Capabilities:

- APIs supported
  - OpenStack Volume API
- Robust extensions mechanism to add new capabilities

# cinder-volume manages individual block-based volume providers

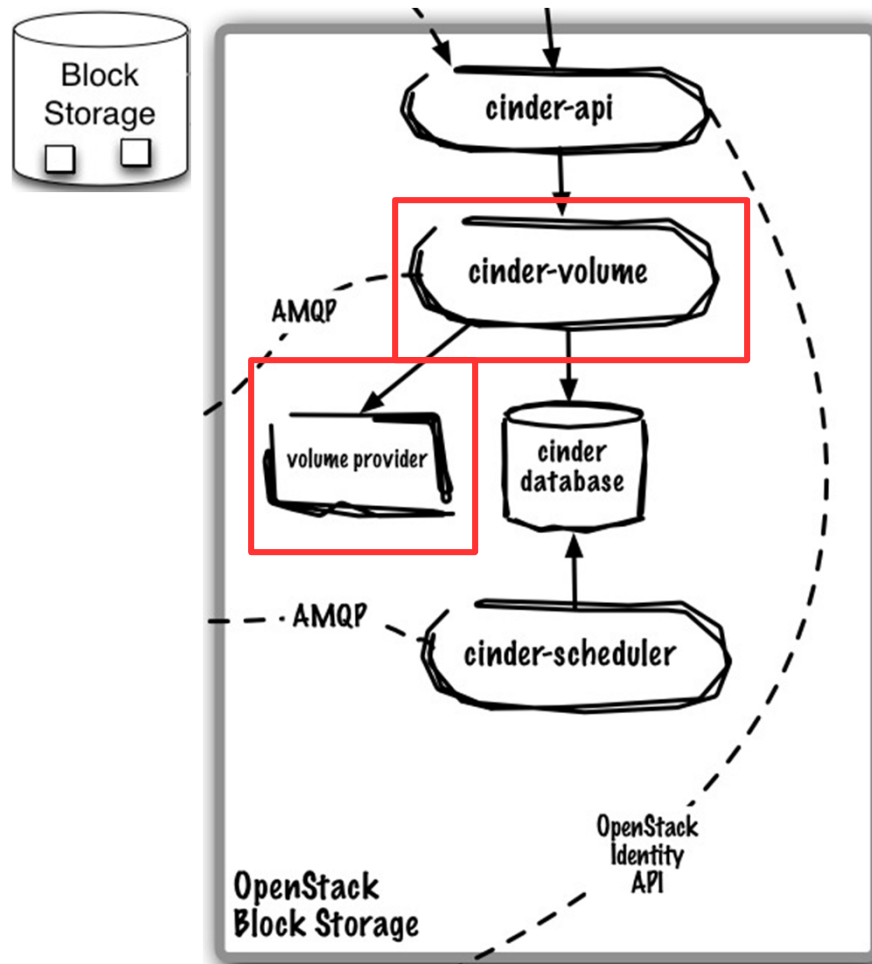

**Core Use Case:**

- Manages interactions with single block volume provider

**Runs As:** Distributed Service

**Deployment Considerations:**

- Many cinder-volume instances exist in the environment to ensure volume provisioning is always available
- Single cinder-volume is not HA, manage single provider to minimize failure domain

**Key Capabilities:**

- Create and manage volumes on storage backend
- Expose volumes to physical host (e.g. iSCSI, FC)
- Uses plug-in model to support differing storage systems

# cinder-scheduler selects cinder-volume instance to place volume on

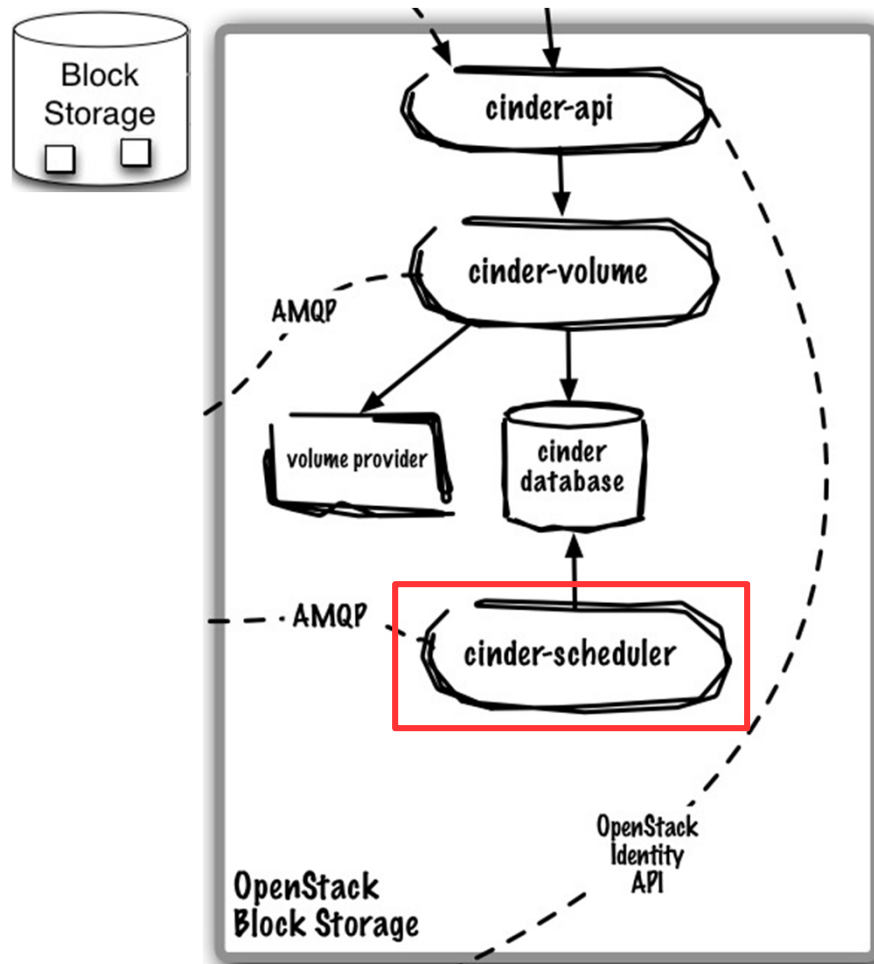

### Core Use Case:

- Selects cinder-volume service to place volume on

### Runs As: Controller Service

### Deployment Considerations:

- Default scheduler is horizontally scalable

### Key Capabilities:

- Default scheduler is allocation-based using a series of filters to reduce set of applicable hosts and uses costing functions to provide weight

## Identity Service (Keystone) offers project-wide identity, token, service catalog, and policy services designed for integration with existing systems

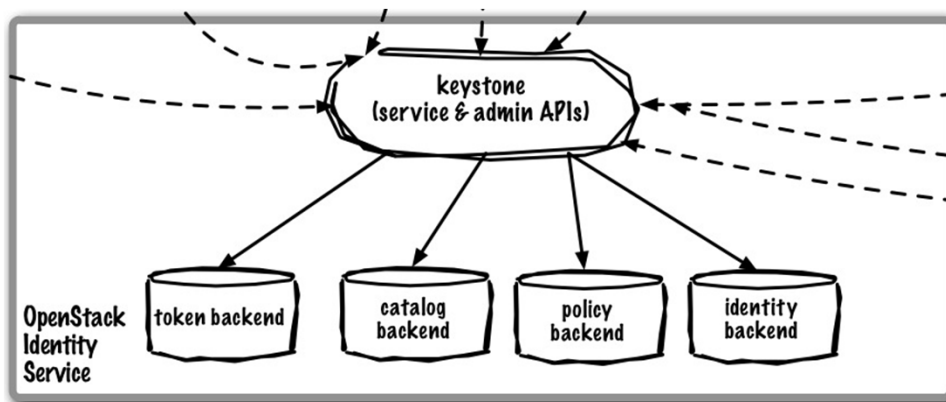

### Core Use Cases:

- Installation-wide authentication and authorization to OpenStack services

### Key Capabilities:

- Authenticate user / password requests against multiple backends (SQL, LDAP, etc) (Identity Service)
- Validate / manage tokens used after initial username/password verification (Token Service)
- Endpoint registry of available services (Service Catalog)
- Authorize API requests (Policy Service)
- Domain / Project / User model with RBAC for access to compute, storage, networking
- Policy service provides a rule-based authorization engine and the associated rule management interface.

## keystone service is the entry point for all AuthN and AuthZ in OpenStack

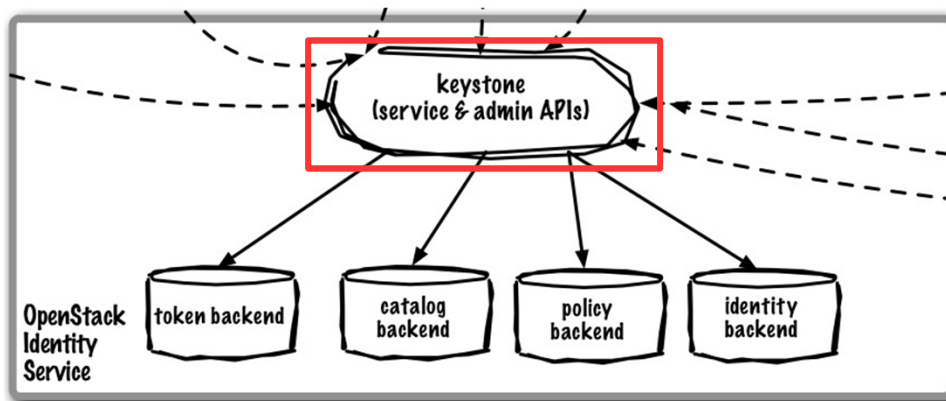

### Core Use Case:

- Handle and service all Identity REST API requests

### Runs As: Controller Service

### Deployment Considerations:

- Horizontally scalable, start many instances
- Front with load-balancer to present as single endpoint

### Key Capabilities:

- APIs supported
  - OpenStack Identity API
- Pluggable backends for each function: identity, token, catalog, and policy

# Glance database persists all image related metadata

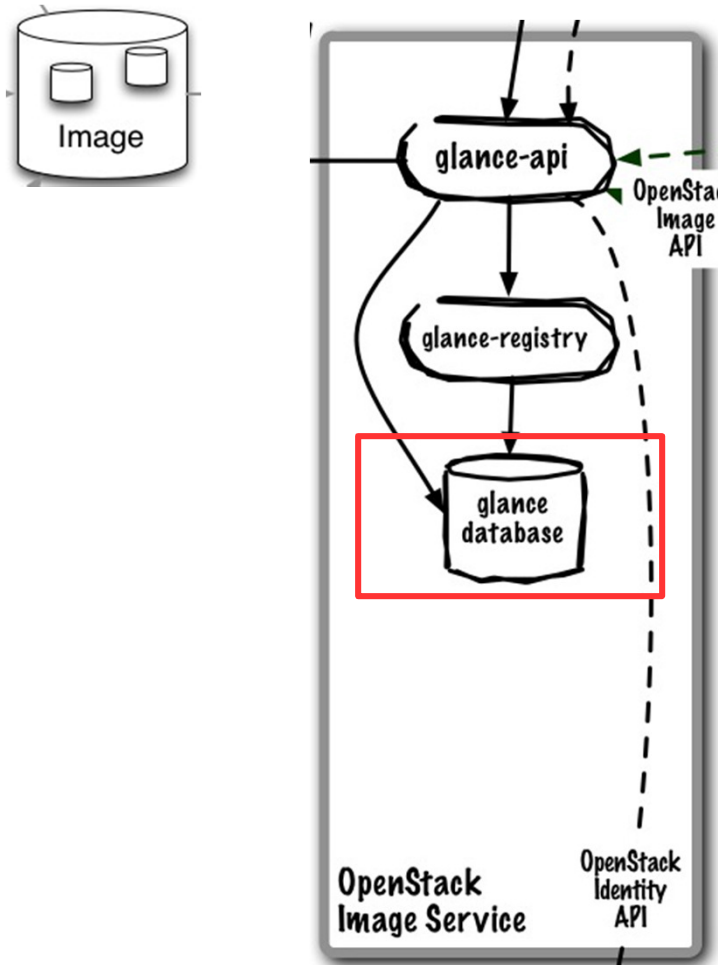

**Core Use Case:**

- Persist image-related metadata

**Runs As:** Controller Service

**Deployment Considerations:**

- Use DB and Queue clustering/HA methods
- Can use same queue/database as Nova

**Key Capabilities:**

- Persists image-related metadata

## Image Service (Glance) provides registration, discovery, and delivery services for virtual disk and server images

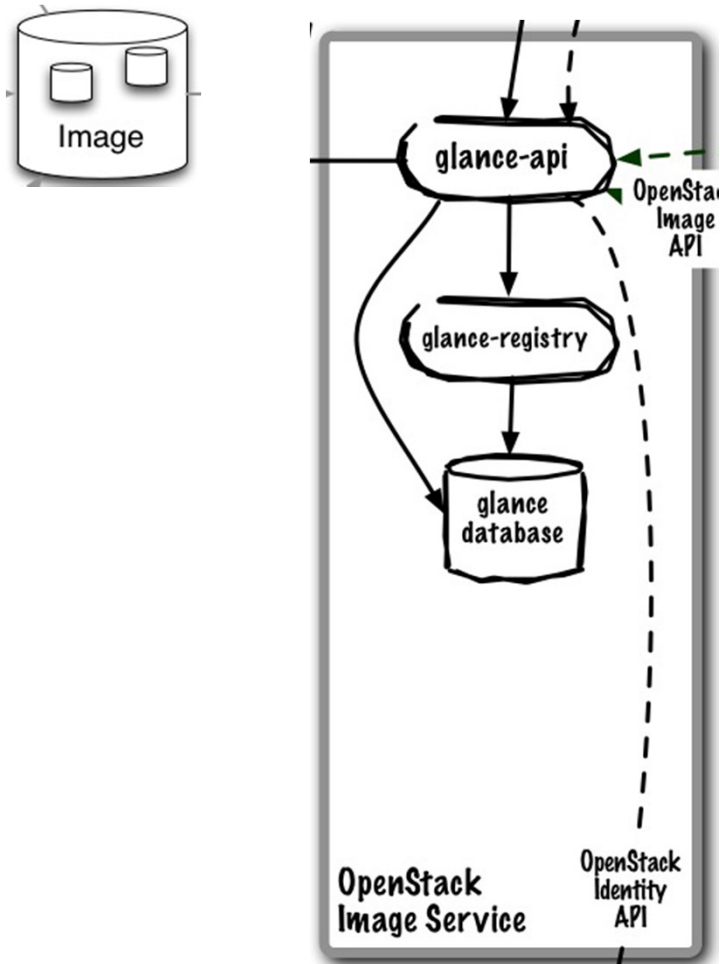

### Core Use Cases:

- Administrator registers available guest images
- End-user discovers available guest images
- Deliver image to compute node on provisioning

### Key Capabilities:

- Image Registry (storage optional and is delegated to a configurable store)
- Administrators can create base templates from which users can start new compute instances
- Users can choose from available images, or create their own from existing servers
- Snapshots can also be stored in the Image Service so that virtual machines can be backed up quickly
- Supported formats: Raw, Machine (a.k.a. Amazon AMI), VHD (Hyper-V), VDI (VirtualBox), qcow2 (Qemu/KVM), VMDK (VMWare), OVF (VMWare, others)

## glance-api routes incoming REST API Requests

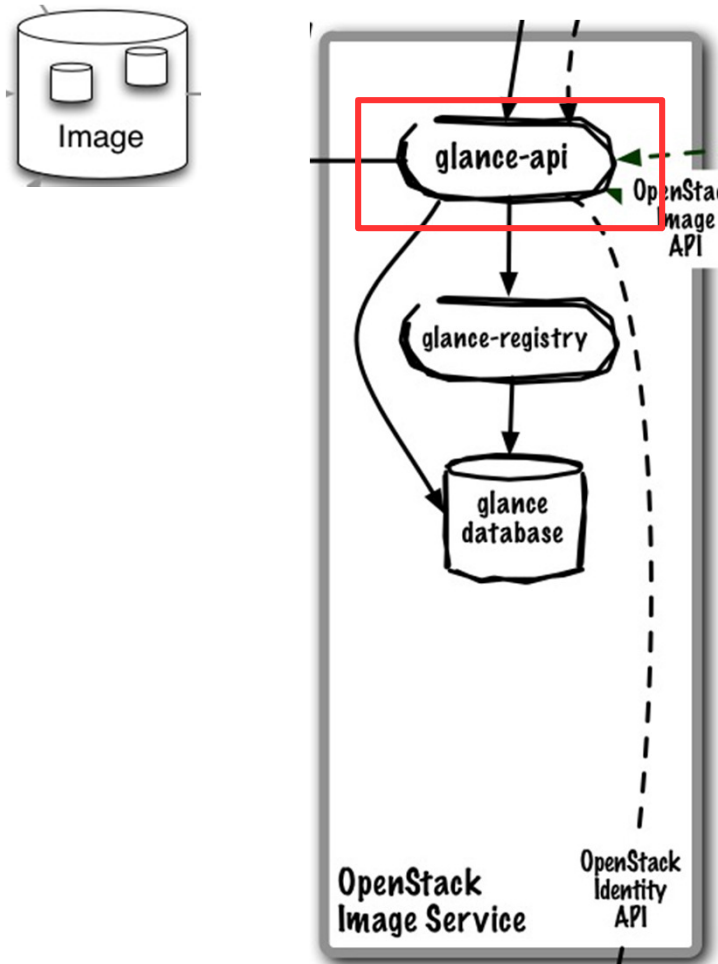

### Core Use Case:

- Routes REST API requests to the appropriate handler

### Runs As: Controller Service

### Deployment Considerations:

- Horizontally scalable, start many instances
- Front with load-balancer to present as single endpoint

### Key Capabilities:

- APIs supported
  - OpenStack Image API
- Routes requests from clients to registries of image metadata and to its backend stores
- Pluggable image store backends



# glance-registry services Image Service API requests

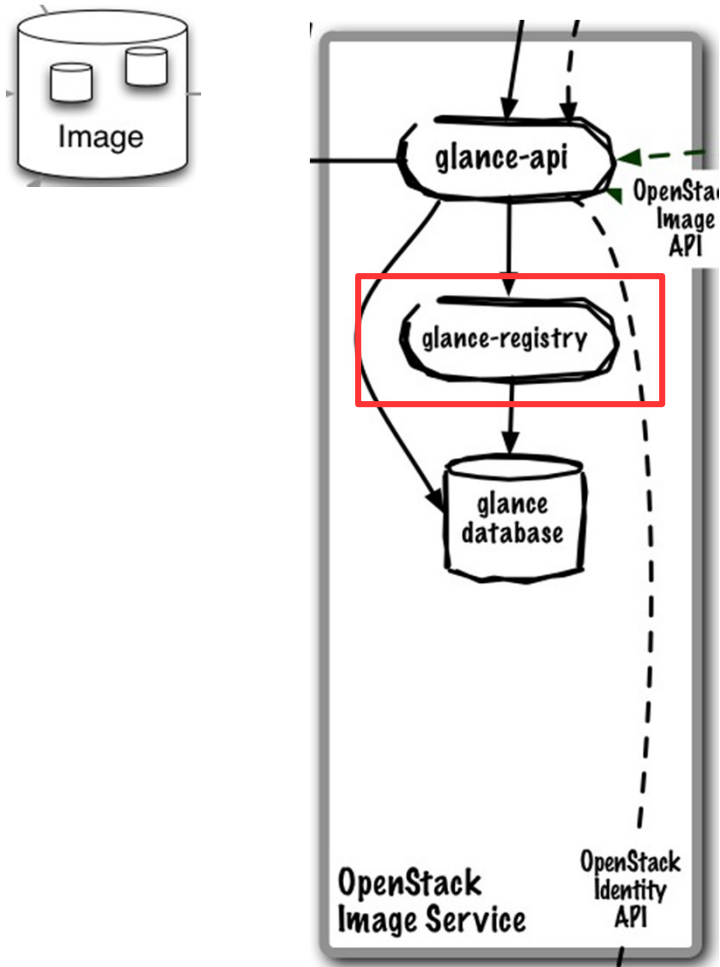

**Core Use Case:**

- Services Identity REST API requests

**Runs As:** Controller Service

**Deployment Considerations:**

- (to be determined)

**Key Capabilities:**

- APIs supported
  - OpenStack Image API

## Horizon (Dashboard) enables administrators and users to access, provision, and manage resources through a self-service portal GUI

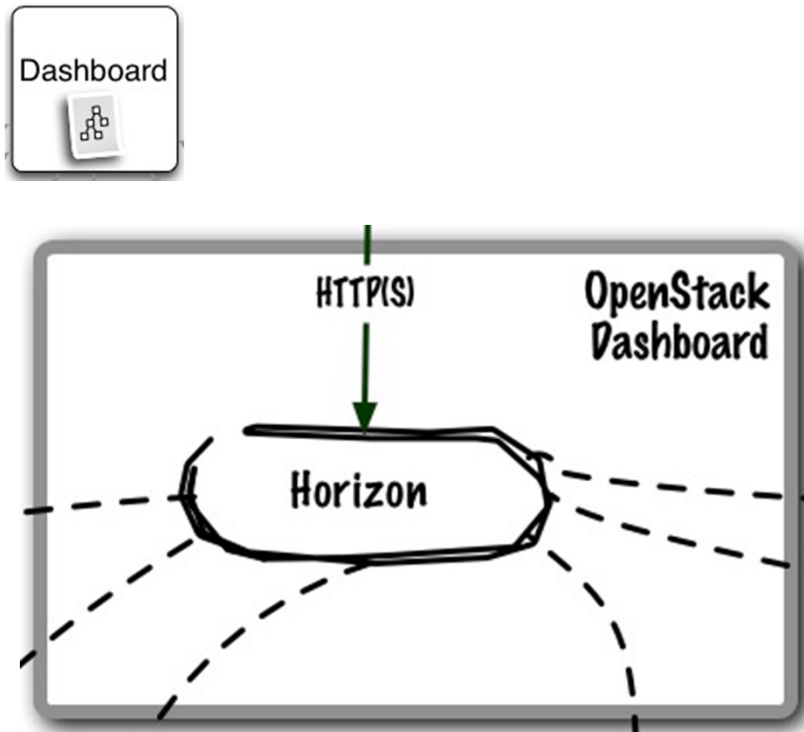

NOT SHIPPED BY IBM

### Core Use Cases:

- Self-service portal for compute and object storage
- Cloud administration (users/projects, quotas, etc.)

### Key Capabilities:

- Thin wrapper over APIs, no local state
- Registration pattern for applications to hook into
- Out-of-the-box support for all core OpenStack projects.
- Anyone can add a new component as a “first-class citizen”.
- Visual and interaction paradigms are maintained throughout.

Image Source: <http://www.solinea.com/2013/04/17/openstack-summit-intro-to-openstack-architecture-grizzly-edition/>

## horizon is the self-service portal implementation

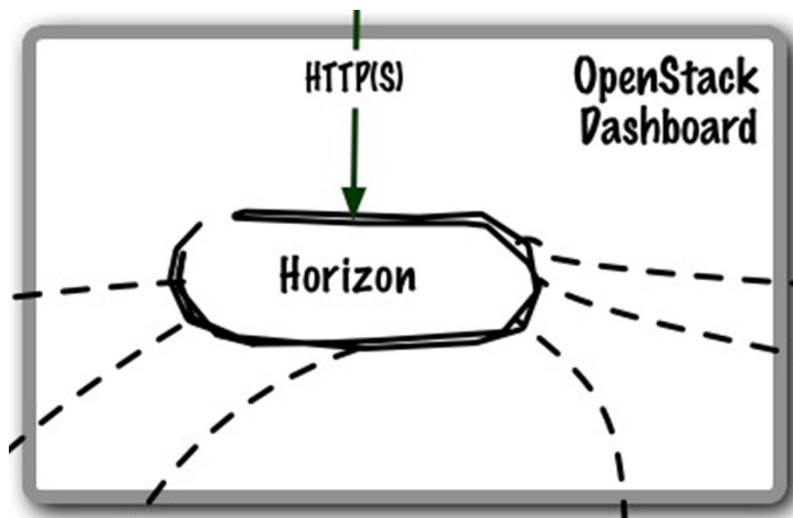

NOT SHIPPED BY IBM

### Core Use Case:

- GUI access to OpenStack APIs

### Runs As: Controller Service

### Deployment Considerations:

- (to be determined)

### Key Capabilities:

- Provision and manage virtual servers, volumes, and networks
- Create and manage tenants and users

# Putting it all together....



- OpenStack Command Line Tools (nova-client, swift-client, etc.)
- Cloud Management Tools (Rightscale, Enstratus, etc.)
- GUI tools (Cyberduck, iPhone client, etc.)

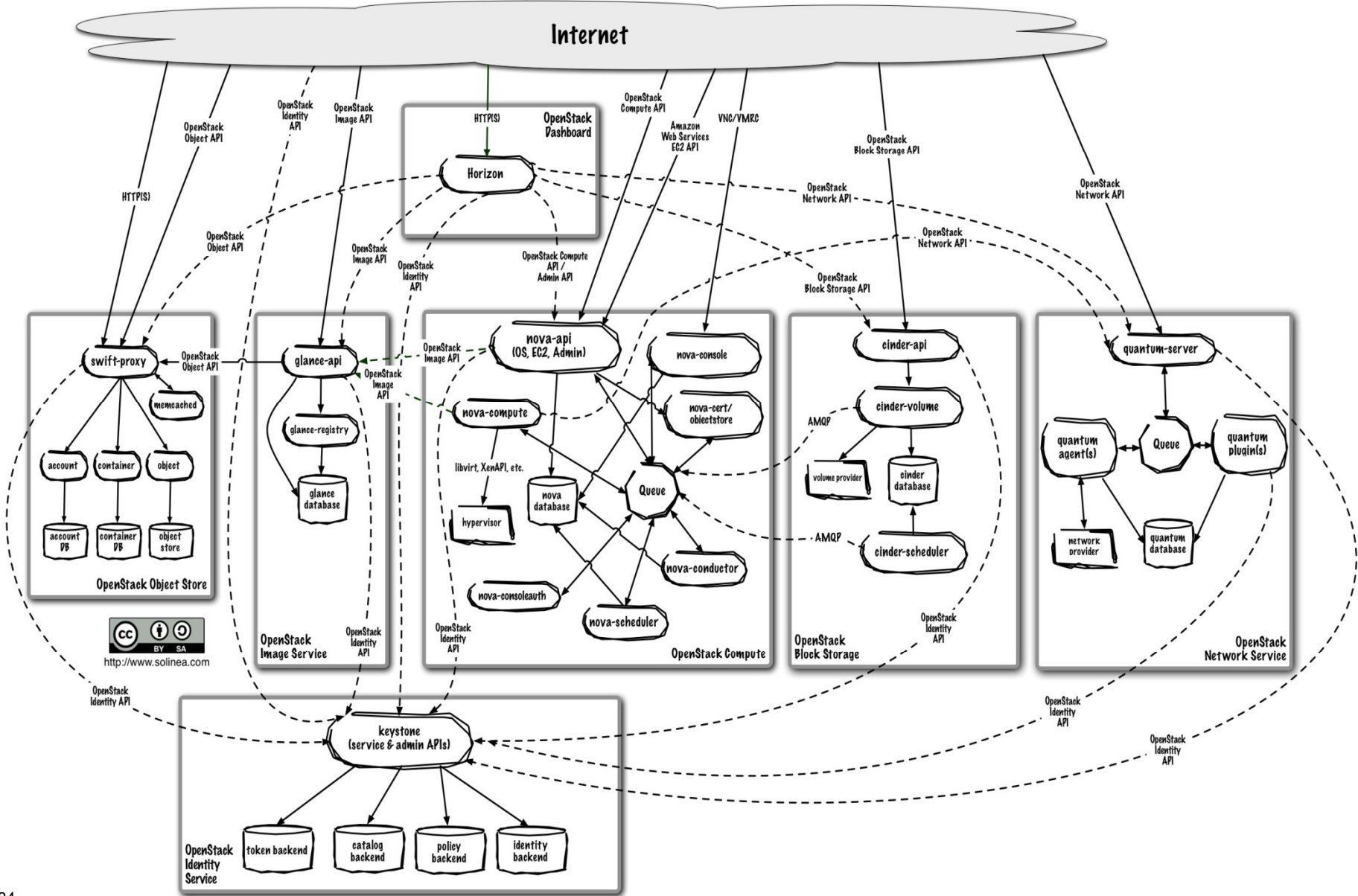



# Additional xCAT Information

## xCAT to be shipped and installed with z/VM

- xCAT Extreme Cloud Administration Toolkit
- Allows for Provisioning
- Function added to xCAT that will be ready for z/VM 6.3
  - **Capture** – ability to capture a virtual machine into an image that can be deployed at a later time.
  - **Deploy** – ability to deploy an image from previously captured image data.
  - **Export** – ability to export an image from a local repository for retention or transmission elsewhere.
  - **Import** – ability to import an image (possibly created elsewhere) into the local image repository.
  - **Delete Image** – ability to remove an image from a local image repository.
  - **List** – ability to discover images in a local image repository and information about the images. This is of primary use to xCAT.
- RESTful API's or interface for OpenStack communication to z/VM



## xCAT Benefits to customers

- Provides out-of-the-box ease of use for many customer tasks
  - Server Deployment
  - Server Lifecycle management
  - Basic Server monitoring
  
- Infrastructure for Additional products to interface to z/VM using the OpenStack interfaces



# xCAT Configuration into z/VM system

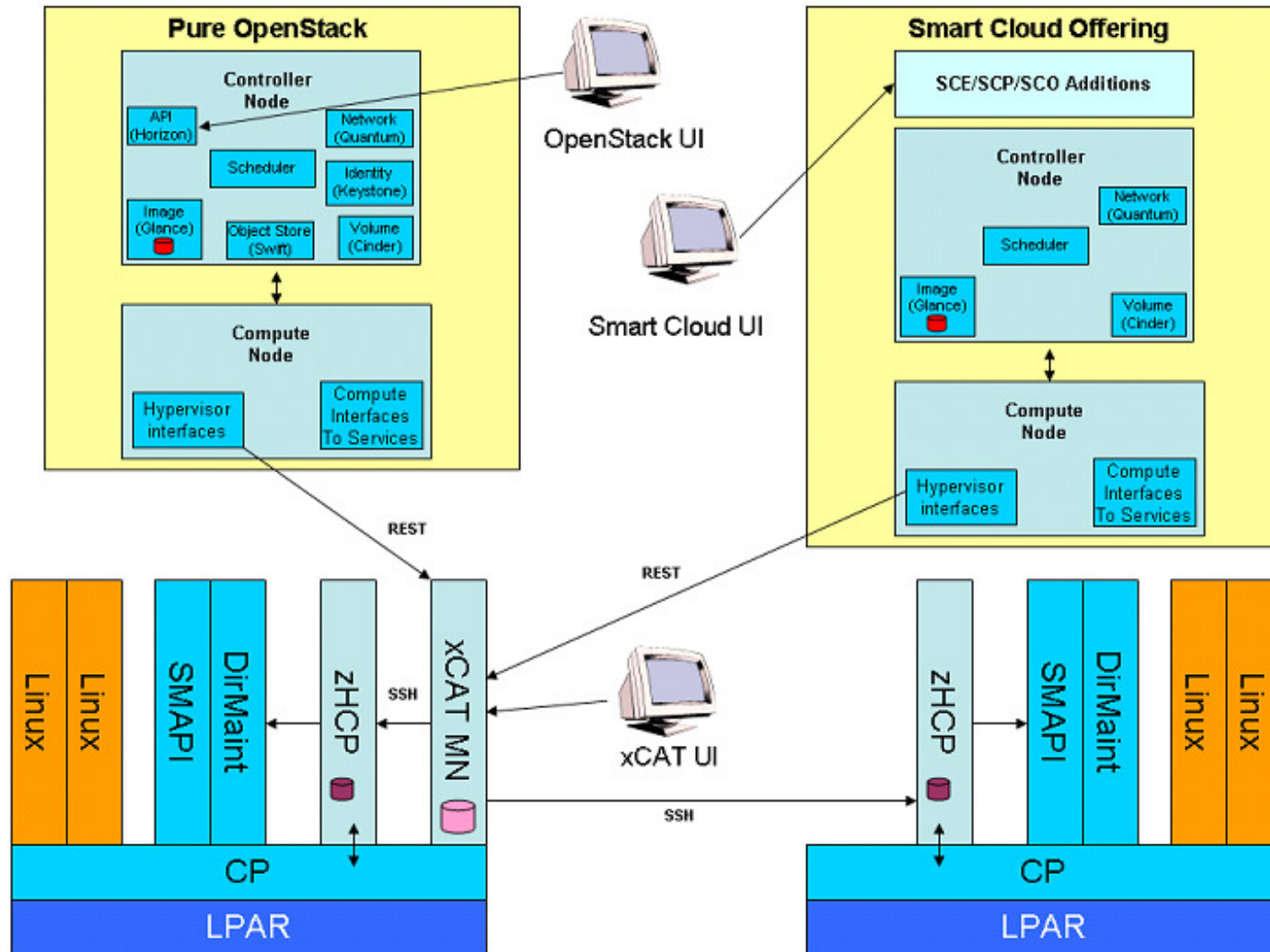



# xCAT Node (or server) screen

The screenshot shows the xCAT web interface in Mozilla Firefox. The browser address bar displays `https://gpok136.endicott.ibm.com/xcat/index.php`. The main navigation bar includes 'Nodes', 'Configure', 'Provision', 'Monitor', and 'Help'. A sidebar on the left lists 'Groups' such as 'all', 'devel', 'existing', 'hcp', 'hosts', and 'support'. The main content area features a 'Nodes' tab and a table of nodes. A yellow tooltip above the table instructs: 'Double-click on a cell to edit a node's properties. Click outside the table to save changes. Hit the Escape key to ignore changes.' The table has columns for 'node', 'status', 'power', 'monitor', 'comments', 'arch', 'groups', and 'hcp'. Below the table, it indicates 'Showing 1 to 18 of 18 entries'.

node	status	power	monitor	comments	arch	groups	hcp
gpok142	ping				s390x	existing,all	gpok3.endicott.ibm.com
gpok157	no ping				s390x	support,all	gpok3.endicott.ibm.com
gpok158	no ping				s390x	support,all	gpok3.endicott.ibm.com
gpok221	ping				s390x	existing,all	gpok3.endicott.ibm.com
gpok224	ping				s390x	existing,all	gpok3.endicott.ibm.com
gpok237	no ping				s390x	existing,all	gpok135.endicott.ibm.com
ihost10	ping				s390x	devel,all	gpok3.endicott.ibm.com
ihost11	ping				s390x	devel,all	gpok3.endicott.ibm.com
ihost12	ping				s390x	devel,all	gpok3.endicott.ibm.com
ihost13	ping				s390x	devel,all	gpok3.endicott.ibm.com
ihost14	ping				s390x	devel,all	gpok3.endicott.ibm.com

# xCAT Node Details

The screenshot shows the xCAT web interface in a Mozilla Firefox browser. The main navigation bar includes 'Nodes', 'Configure', 'Provision', 'Monitor', and 'Help'. The left sidebar shows a 'Groups' menu with options like 'all', 'dev', 'existing', 'hcp', 'hosts', and 'support'. The main content area displays details for node 'ihost13' under the 'Nodes' tab.

**General Information:**

- z/VM UserID: IHOST13
- z/VM Host: POKDEV61
- Operating System: Red Hat Enterprise Linux Server release 6.2 (Santiago)
- Architecture: s390x
- Uptime: 0 days 3 hr 15 min
- CPU Used Time: 19122277 uS

**Hardware:**

**Privileges:**

- Currently: G
- Directory: G

**Total Memory:** 512M

**Processors:**

Type	Address	ID	Base	Dedicated	Affinity
CP	01	FF00EBBE20978000	false	false	ON
CP	00	FF00EBBE20978000	true	false	ON

**Disks:**

Virtual Device #	Type	VolID	Type of Access	Size
0190	3390	EV61A2	R/O	107 CYL
0191	3390	EMC20D	R/O	1000 CYL
019D	3390	EV61A2	R/O	146 CYL
019E	3390	EV61A2	R/O	250 CYL
0402	3390	EV61A2	R/O	146 CYL

# xCAT Node Details - cont.

xCAT - Mozilla Firefox: IBM Edition

File Edit View History Bookmarks Tools Help

SmartCloud Meetings for IBM xCAT

ibm.com https://gpok136.endicott.ibm.com/xcat/index.php

Most Visited Headlines Skills IBM W Start Nxt Oth 12 NASCAR S BGM deck Vac Maps land car CELL Madl Org - Education P...

**Privileges**

Currently: G

Directory: G

**Total Memory**

512M

**Processors**

Type	Address	ID	Base	Dedicated	Affinity
CP	01	FF00EBBE20978000	false	false	ON
CP	00	FF00EBBE20978000	true	false	ON

[+ Add temporary processor](#)

**Disks**

Virtual Device #	Type	VolID	Type of Access	Size
0190	3390	EV61A2	R/O	107 CYL
0191	3390	EMC20D	R/O	1000 CYL
019D	3390	EV61A2	R/O	146 CYL
019E	3390	EV61A2	R/O	250 CYL
0402	3390	EV61A2	R/O	146 CYL
0592	3390	EV61A2	R/O	70 CYL

[+ Add disk](#)

**zFCP**

Virtual Device #	Port Name	Unit Number	Size
3b77	0x500507630613c411	0x4014402f00000000	2048.0 MIB
3b77	0x500507630613c411	0x4014403200000000	8192.0 MIB

[+ Add dedicated device](#)

[+ Add zFCP](#)

**NICs**

Virtual Device #	Adapter Type	Port Name	# of Devices	LAN Name
0600.P00	QDIO	UNASSIGNED	3	SYSTEM VSW1
0700.P00	QDIO	UNASSIGNED	3	* None
0800.P00	QDIO	FOOBAR	3	SYSTEM VSW2

[+ Add NIC](#)

# xCAT Directory Entry (editable directly)

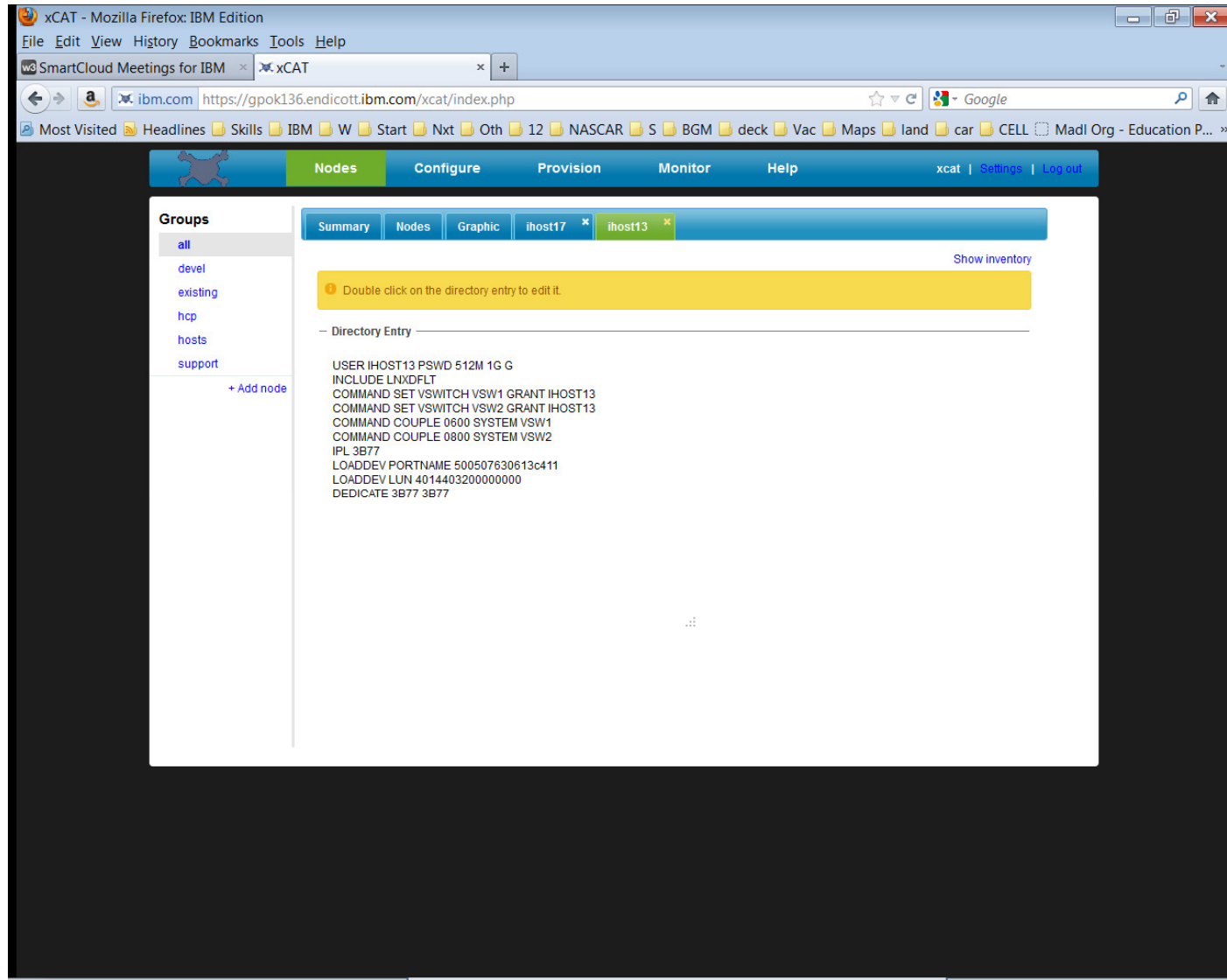



# Additional IBM Wave Information

# IBM Wave Intelligent Visualization

## Quickly Understand the Status of System Resources

- **Get a current and accurate view of your managed environment**
  - Network Topology
    - Centralized view of the entire network topology per z/VM System, view Virtual LANS (VLANS)
    - Annotate network topology view to identify external resources - routers, switches, etc
  - Linux Servers
    - View performance gauges for all z/VM systems from one screen:
    - See resource consumption by guest or type
    - CPU, Virtual to Real, Paging, Spool
  - Storage
    - Visual representation of all storage resources
- **Visualize and control virtual resources**
  - Views can be graphical or easily switched to tabular mode
  - View relationships between resources easily and graphically
  - View the entire environment graphically and easily zoom in
- **Advanced filters, tagging, layout and layer based views for every display**

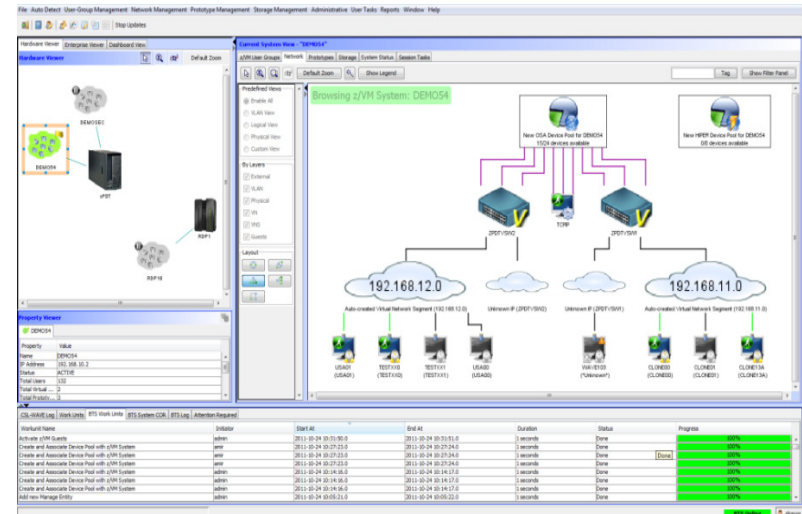

# Intelligent Visualization

## Mapping Attached Storage to Guests and Storage Controllers

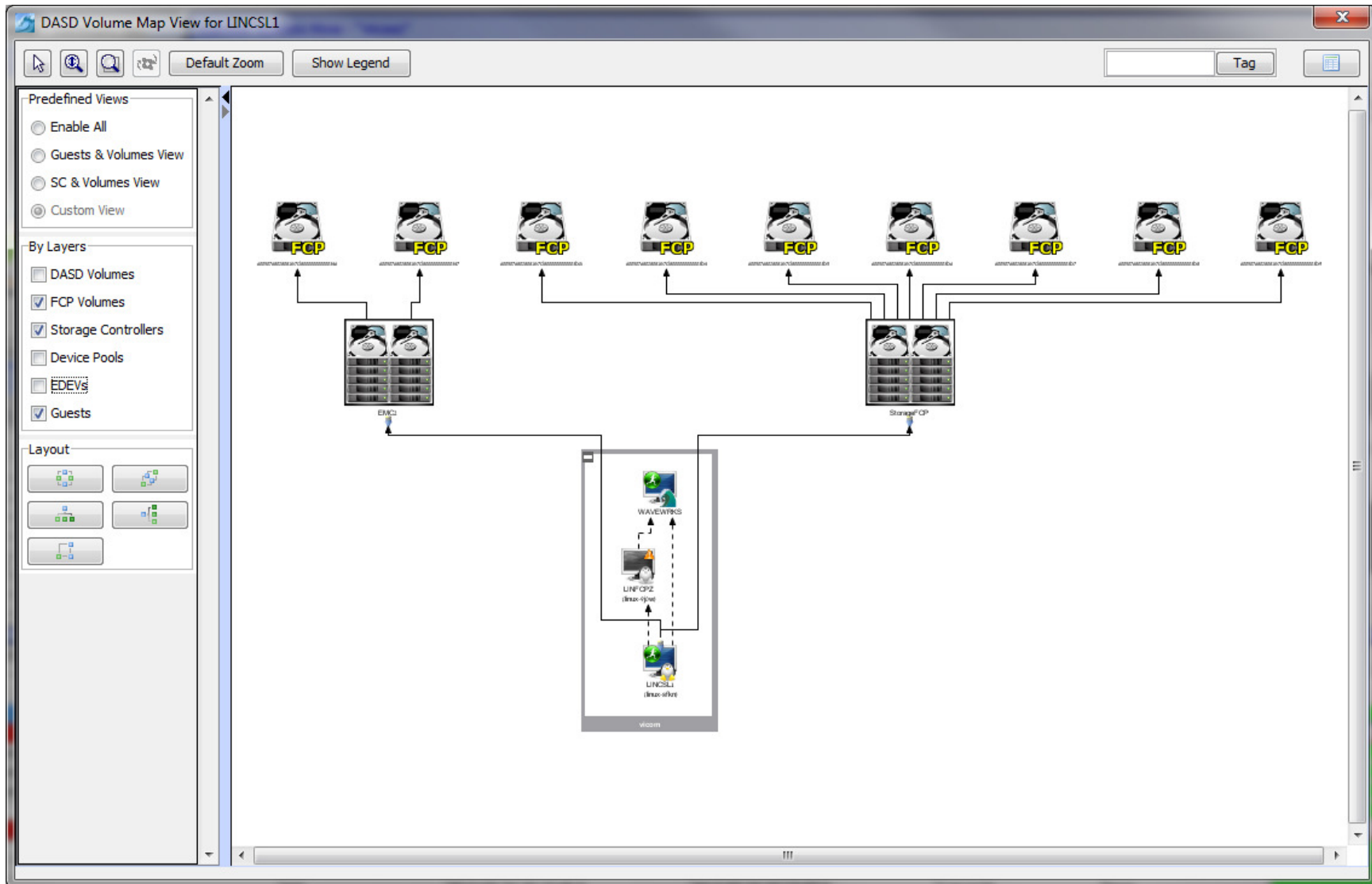

# IBM Wave Simplified Monitoring

## Automatic Detection and Monitoring of Resources

### ▪ Agentless Resource Discovery

- Discover, manage and monitor z/VM resources and their relationships across multiple LPARs and CECs
- Identify resource and relationship changes; reflect current environment in the user interface

### ▪ Monitoring

- Allows the state of resources to be observed; icons show additional content for the resources
- Use graphical and tabular displays with layered drill down to hone in on only the resources you need to view
- Perform ongoing monitoring of changes that occur after initial auto-detection

### ▪ Reporting

- Automatically generate charts like pie charts to report on utilization and more
- All table-based views can be exported to a CSV file for import into other applications

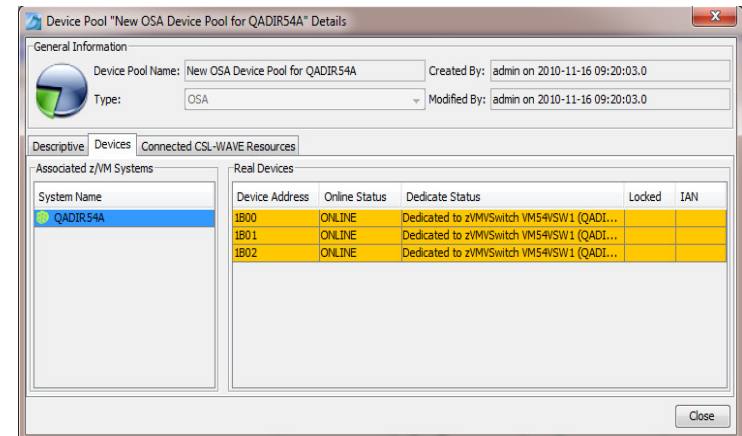



# Performance Resource Monitoring

## At a Glance Status of all z/VM instances

CSL-WAVE 3.1.0 (WAVESERV Hostname: N/A, IP Address: 192.168.1.183)

File Auto Detect User-Group Management Network Management Prototype Management Storage Management Administrative User Tasks Reports Window Help

Stop Updates

Hardware Viewer Enterprise Viewer Dashboard View

**Enterprise Dashboard View**

Enterprise Status Viewer

Filter selection  
CPC = +

Clear Go

Property Viewer

3 (vicom) LINCSSL2 (vicom)

Property	Value
Name	LINCSSL2
Status	Inactive
Eligible	Yes
Group	USER-LOCAL
Type	Linux
Distribution	SLES11 - 64 Bit
1st IP Address	10.100.0.45
Project	N/A
Functionality	N/A

z/VM System Name	CPU Utilization	Virtual to Real memory	Page Space Utilization	Spool Space Utilization
ETPGVBJ	z/VM CPU Utilization: 0.0%	Virtual to Real memory: 52.0%	z/VM Page Space Utilization: 0.0%	z/VM Spool Space Utilization: 1.0%
vicom	z/VM CPU Utilization: 0.0%	Virtual to Real memory: 141.0%	z/VM Page Space Utilization: 1.0%	z/VM Spool Space Utilization: 22.0%

CSL-WAVE Log Work Units BTS Work Units BTS System COR BTS Log Attention Required

Workunit Name	Initiator	Start At	End At	Duration	Status	Progress
Init z/VM Guests for CSL-WAVE	amir	2012-05-28 18:53:28.0	2012-05-28 18:54:36.0	1:08 minutes	Done	100%
Init z/VM Guests for CSL-WAVE	amir	2012-05-28 18:53:10.0	2012-05-28 18:53:14.0	4 seconds	Error	
Refresh Linux Data for z/VM Guests	amir	2012-05-28 18:52:00.0	2012-05-28 18:52:32.0	32 seconds	Done	100%
Refresh Linux Data for z/VM Guests	amir	2012-05-28 18:48:53.0	2012-05-28 18:51:23.0	2:30 minutes	Done	100%
Refresh Linux Data for z/VM Guests	amir	2012-05-28 15:16:15.0	2012-05-28 15:16:41.0	26 seconds	Done	100%
Refresh Linux Data for z/VM Guests	amir	2012-05-24 21:18:29.0	2012-05-24 21:20:04.0	1:35 minutes	Done	100%
Create New FCP Volume Group	amir	2012-05-24 21:15:26.0	2012-05-24 21:15:32.0	6 seconds	Error	
Create New FCP Volume Group	amir	2012-05-24 20:43:32.0	2012-05-24 20:45:03.0	1:31 minutes	Done	100%
Init z/VM Guests for CSL-WAVE	amir	2012-05-24 19:33:37.0	2012-05-24 19:34:34.0	57 seconds	Done	100%
Sync NFS Servers	amir	2012-05-24 19:12:45.0	2012-05-24 19:12:47.0	2 seconds	Done	100%

BTS Online amir

# Performance Resource Monitoring

## At a Glance Drill down to Virtual Memory Detail

Current Real and Virtual Memory Values

Type	Size	Ratio Display
Total Real Memory	7000M	7000
Total Virtual Memory	6020M	6020

Virtual to Real Ratio

86%

Virtual Memory Utilization for All Guests - Last Updated: 08:45:24 EDT WEDNESDAY 06/19/13

Name	Type	Memory (MB)	VDisks (MB)	Total (MB)	% Used
CSLSSI2	CMS	1200	0	1200	19%
CSLSSI1	CMS	1200	0	1200	19%
NEWTEST1	Linux	128	500	628	10%
ISRAEL0	Linux	128	0	128	2%
TEMP0	Linux	128	0	128	2%
IONPWR2	Linux	128	0	128	2%
IONPWR1	Linux	128	0	128	2%
WAVEWRKC	CSL-WAVE	32	0	32	0%
WAVEWRKL	CSL-WAVE	32	0	32	0%
WAVEWRKS	CSL-WAVE	32	0	32	0%

Include IBM Service Machines

Virtual Memory Usage Distribution (By Guest)

Virtual Memory Usage Distribution (By Type)

# IBM Wave Unified Management

## Managing the Entire Pool of Resources Intuitively

- **Simplification**

- Simplify the process of performing a function across multiple z/VM or Linux systems

- **Manage Networks**

- Centralized, layer based customizable view of the entire z/VM network topology
- Define and control all network devices such as VSWITCHes and guest LANs

- **Manage Storage**

- Manage devices and device pools

- **Provision Resources**

- Clone resources and virtual servers, apply scripts for more customization
- Install Linux on virtual machines
- Adding attached storage to z/VM Guests using IBM Wave's Manage Storage Wizard
- Activate/Deactivate servers in an ordered fashion

- **Improve Policy Management**

- Use reminder notes attached to icons to provide advisory and policy notices

# Simplify Systems Management Tasks

## Provision resources quickly and easily

CSL-WAVE 3.2.0 (WAVESERV Hostname: csldrv13, IP Address: 192.168.39.77)

File Auto Detect User-Group Management Network Management Prototype Management User Tasks Reports Window Help

Stop Updates

Hardware Viewer Enterprise Viewer Dashboard View

Hardware Viewer Default Zoom

ATSEC12

CSLVM13

Property Viewer

CSLVM13 CSLRHEL (CSLVM13)

Property	Value
Name	CSLRHEL
Status	Inactive
Eligible	Yes
Group	USER-LOCAL
Type	Linux
Distribution	RedHat 6 - 64 Bit
1st IP Address	192.168.39.75
Project	DMV
Functionality	N/A

CSL-WAVE Log | BTS Work Units | BTS System COR. | BTS Log

WAVESRV Time	User
2014-01-28 17:08:41	dmvuser
2014-01-28 17:09:39	dmvuser

Waiting for user input

BTS Online dmvuser 5:11 PM

# IBM Wave Systems Management Task Example

## Add Disk Space To A Virtual Server

### Without IBM Wave

1. Find requested disk space
2. Create disk definition
3. Activate definition
4. Connect storage to virtual server
5. Mount device
6. Create a File System

### With IBM Wave

1. Open the “Add Storage” form
2. Fill the storage capacity requested
3. Press the “Go” button

### Benefits:

- ✓ Reduce reliance on scarce skills
- ✓ Respond faster to IT customer needs
- ✓ Reduce costs
- ✓ Empower team to do more independently
- ✓ Simplify management
- ✓ Accurately depict current environment
- ✓ Reduce manual procedure errors
- ✓ Avoid problematic situations downstream

### View Storage at a Glance

The screenshot displays the 'DASD Volume Map View for LINCFCPT' window, which provides a visual overview of storage resources and their allocation to virtual servers. A secondary window, 'Manage z/VM User LINC512 Storage', is open, showing detailed information for a specific virtual server.

**Manage z/VM User LINC512 Storage - General Information**

- z/VM Guest Name: LINC512
- z/VM System Name: Vicos-74
- SDG Name: USER-LOCAL

**Linux File Systems LMM Volume Groups**

Device	FS Type	Size (GB)	used (GB)	Free (GB)	Type	Storage Type	Mount Point	Status (Capacity)
dev/casda1	ext3	1.35	1.01	0.28	STD	OID	/	74%
proc	proc	0.00	0.00	0.00	STD	OID	/proc	0%
sysfs	sysfs	0.00	0.00	0.00	STD	OID	/sys	0%
debugfs	debugfs	0.00	0.00	0.00	STD	OID	/sys/kernel/debug	0%
udev	tmpfs	0.71	0.00	0.71	STD	OID	/dev	0%
devpts	devpts	0.00	0.00	0.00	STD	OID	/dev/pts	0%
fssect1	fssect1	0.00	0.00	0.00	STN	STN	/usr/share/zoneinfo/...	0%
securityfs	securityfs	0.00	0.00	0.00	STN	STN	[0.00 GB (Right-click to extend partition)]	0%

# IBM Wave Systems Management Task Example: Clone a Virtual Machine

## Without IBM Wave

1. Determine if required resources exist
2. Create clone VM definition
3. Define clone VM resources
4. Create copies of private VM resources (server)
5. Create copies of private VM resources (disk)
6. Customize clone VM
7. Authorize clone VM access / VSwitch Access
8. Add clone to management groups
9. Activate clone
10. Configure the network
11. Run middleware configuration scripts
12. Monitor and report on cloning operation.

## With IBM Wave

1. Open the “Clone” form
2. Fill in the needed information
3. Press the “Go” Button

### Benefits:

- ✓ Reduce time for a highly complex task
- ✓ Reduce costs
- ✓ Reduce reliance on scarce skills
- ✓ Improve speed to clone
- ✓ Simplify management
- ✓ Reduce errors associated with manual procedures
- ✓ No need to monitor every step of the process



## Clone a Linux Virtual Server

# IBM Wave Systems Management Task Example

## Live Guest Relocation

### Without IBM Wave

- Using manual control program commands

Task	Task Steps
Log into both z/VM instances	Login PBCVMA Login PBCVMB
Find out which instance has the running guest	q HTTP2 in PBCVMA q HTTP2 in PBCVMB
Verify the guest can be moved	vmrelo test HTTP2 to PBCVMB
Move the guest	vmrelo move HTTP2 to PBCVMB
Log out of both z/VM instances	Logoff PBCVMA Logoff PBCVMB

### With IBM Wave

- Using the GUI's Drag-and-Drop techniques
- Or Execute via menu selection

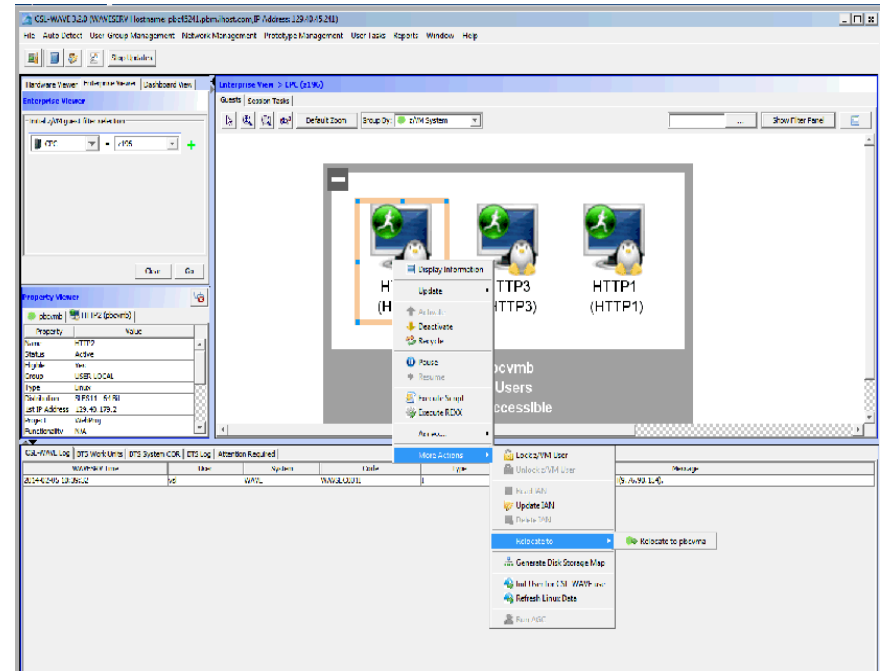

Benefits	IBM Wave for z/VM Capabilities
<ul style="list-style-type: none"> <li>✓ Gain efficiencies in virtualization management</li> <li>✓ Work with a current, accurate and complete view of your managed z/VM environment</li> </ul>	<ul style="list-style-type: none"> <li>▪ IBM Wave provides a high level view of performance, storage usage, networks at a glance with built-in reporting</li> <li>▪ IBM Wave enables automation of management tasks and can incorporate scripts.</li> <li>▪ By providing an up to date, accurate view of the IT environment through its “agent-less discovery” organizations can plan, change and optimize their virtualized resources accurately</li> </ul>
<ul style="list-style-type: none"> <li>✓ Simplify administrative, operations and systems functions</li> <li>✓ Enable improved self service to reduce costs</li> </ul>	<ul style="list-style-type: none"> <li>▪ Tasks that would otherwise take hours and require significant z/VM knowledge such as Live Guest Relocation, Server Cloning and Storage provisioning can be performed quickly and easily</li> <li>▪ Make common management tasks accessible to more user roles</li> </ul>
<ul style="list-style-type: none"> <li>✓ Respond quickly to changing business needs</li> <li>✓ Reduce errors with appropriate delegation</li> </ul>	<ul style="list-style-type: none"> <li>▪ Easily delegate administrative capabilities to the appropriate users</li> <li>▪ Enforce segregation policies at the individual administrator as well as the group level</li> <li>▪ Set scope and permissions to match business requirements</li> </ul>



Benefits	IBM Wave for z/VM Capabilities
<ul style="list-style-type: none"> <li>✓ Improve service levels</li> <li>✓ Easily respond to changing requirements.</li> <li>✓ Reduce time spent on administrative efforts</li> </ul>	<ul style="list-style-type: none"> <li>▪ Offers easy, convenient access to performance and management information –at a glance</li> <li>▪ Helps you quickly and easily administer and provision resources like servers, storage, user accounts.</li> <li>▪ Tag resources with meaningful notes to help enforce installation defined rules.</li> </ul>
<ul style="list-style-type: none"> <li>✓ Easily manage virtualized environments</li> <li>✓ Simplify and accelerate your journey to cloud</li> </ul>	<ul style="list-style-type: none"> <li>▪ Lets you provision new servers and easily clone Linux virtual servers and other resources</li> <li>▪ Scripts allow customization of a golden master.</li> <li>▪ Support early virtualization steps needed to get to a private cloud.</li> </ul>
<ul style="list-style-type: none"> <li>✓ Create audit trails of IBM Wave users' activities</li> </ul>	<ul style="list-style-type: none"> <li>▪ List tasks and status requested by the users with respect to their scope.</li> <li>▪ Log each operation that changes the system including logon and logoff to provide an audit trail. The logs may be then routed to a centralized logging mechanism for further filtering or processing.</li> </ul>
<ul style="list-style-type: none"> <li>✓ Simplify your administration</li> <li>✓ Extend the reach of your existing IT staff</li> </ul>	<ul style="list-style-type: none"> <li>▪ IBM Wave automates a sequence of VM commands, reducing steps needed to complete common administrative and management tasks—and improve consistency.</li> <li>▪ IBM Wave helps your team manage additional servers even if you do not have a deep expert skills bench available.</li> </ul>

# IBM Wave Architecture

## Client

- The Client can run on Microsoft® Windows®, running Java™ 1.7
- Graphic interpretation of the TVP through communication with WAVESRV using Point-and-Click and Drag-and-Drop operations

## WAVESRV

- This server (virtual or physical) hosts the application database and Background Task Scheduler
- One BTS server can manage many Target Virtualization Platforms.

## TVP

- The Target Virtualization Platform (TVP) represents the hypervisor which hosts the virtual guests that are managed.
- The BTS utilizes the TVP API to query and perform changes to the TVP and hosted virtual guests.

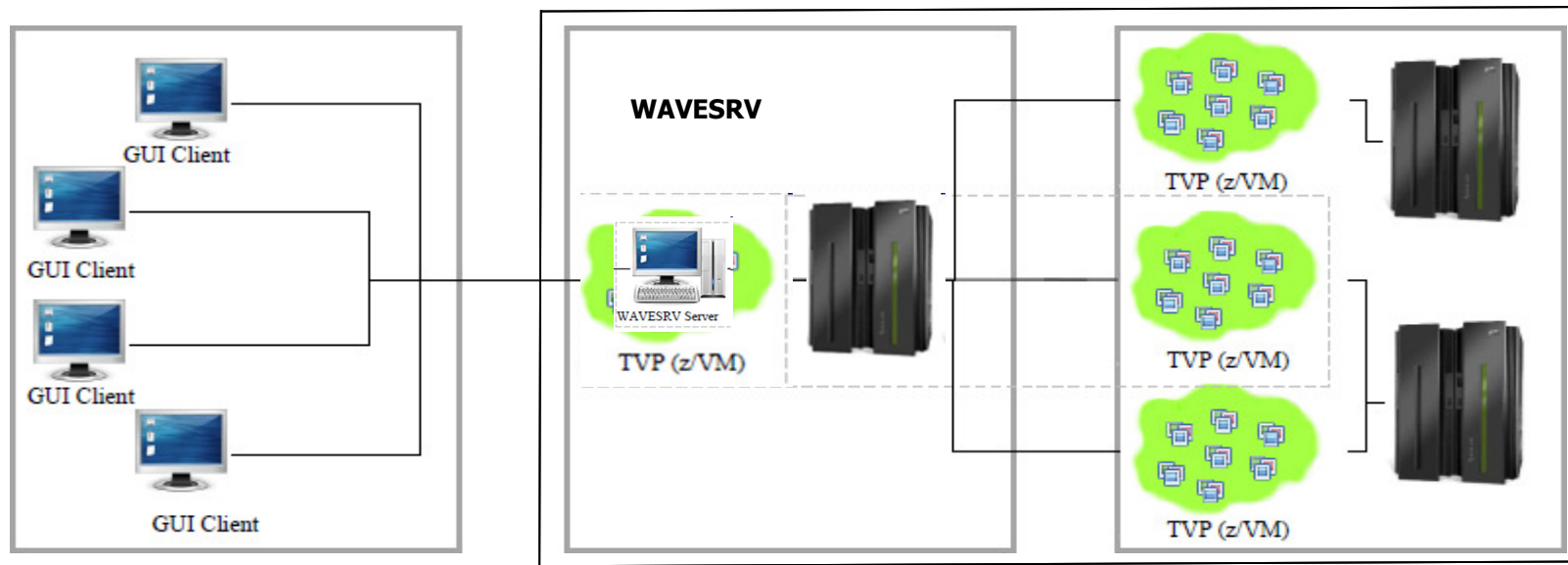

# IBM Wave Requirements

## Client

- Windows 7 Workstation
- Internet Explorer or Firefox
- Java Runtime 1.7 with Web Start Support
- PuTTY or equivalent telnet/SSH client

## WAVESRV

- z/VM Guest or LPAR
- RHEL 6 or SLES 11
- MySQL V12.22 or higher
- Java SE Runtime 1.7
- Apache

## TVP

- IBM System z10® or later
- z/VM V5.4, V6.2 or higher with Systems Management API configured
- IBM Directory Maintenance for z/VM (DirMaint™) or equivalent
- Performance Toolkit for VM™ (Perfkit, optional but suggested)

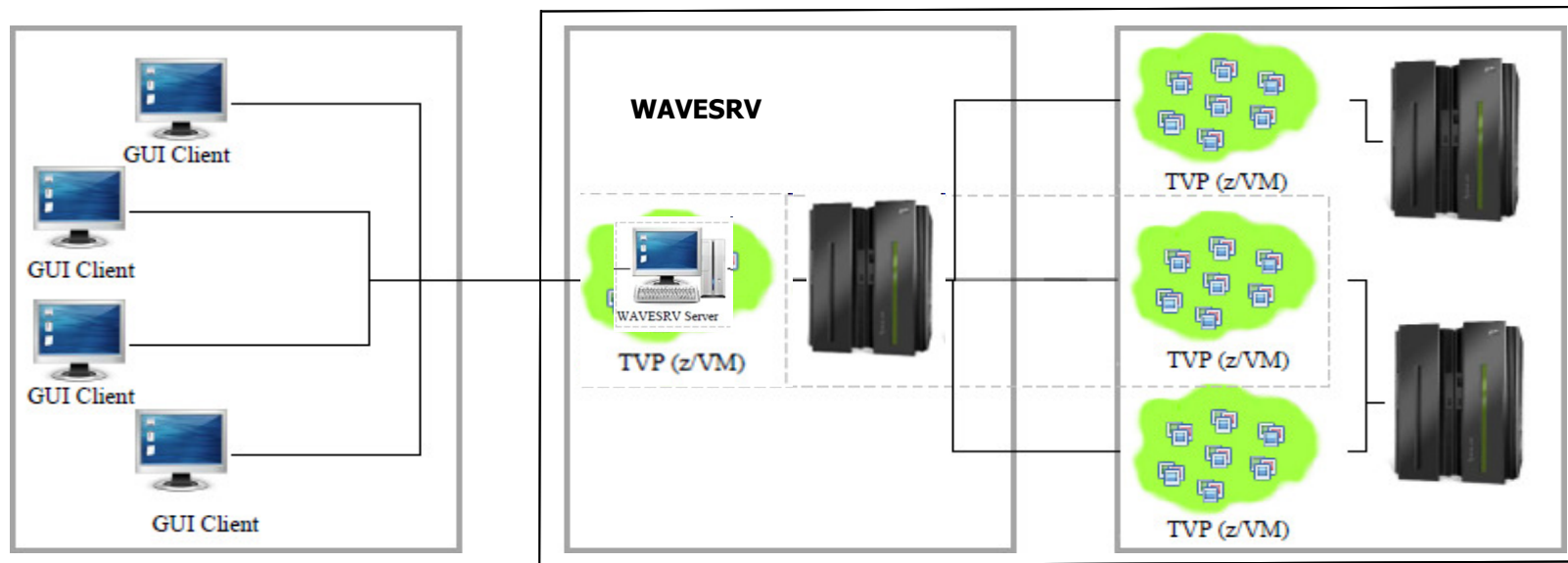



# Where IBM Wave Fits in the Cloud Blueprint

## Integrate

**Virtualization  
Infrastructure &  
Virtualization Management**

### *Differentiation*

- Rapid deployment of Linux virtual servers for less than \$1 a day
- Industry leading "gold standard" security for tenant isolation
- Elastic scaling achieved by dynamically adjustable capacity at sustained performance
- Simplified and empowered virtualization management with IBM Wave
  - z/VM
  - IBM Wave
  - Linux on IBM System z®

## Automate

**Entry Level Cloud  
Standardization & Automation**

### *Standardization*

- Automated provisioning and de-provisioning
- Pool standardized virtualized building blocks
- Plug-and-play capacity across hardware generations
- Capture and catalog virtual images in the data center
- Automated methods for faster delivery of services with higher levels of control
  - xCAT
  - SmartCloud Entry\*

## Orchestrate

**Advanced Cloud  
Service Lifecycle Management**

### *Service Management*

- Integrated virtualization management with IT service delivery processes
- Self-service provisioning
- Automated service lifecycle management including dynamic instantiation of cloud services
- Pay for use
- Optimize IT resources to reinvent business processes
  - Cloud Ready for Linux on System z
  - SmartCloud Provisioning\*
  - SmartCloud Orchestrator\*

\* System z support currently in development

# Learn More with IBM Wave Client Hands on Experience

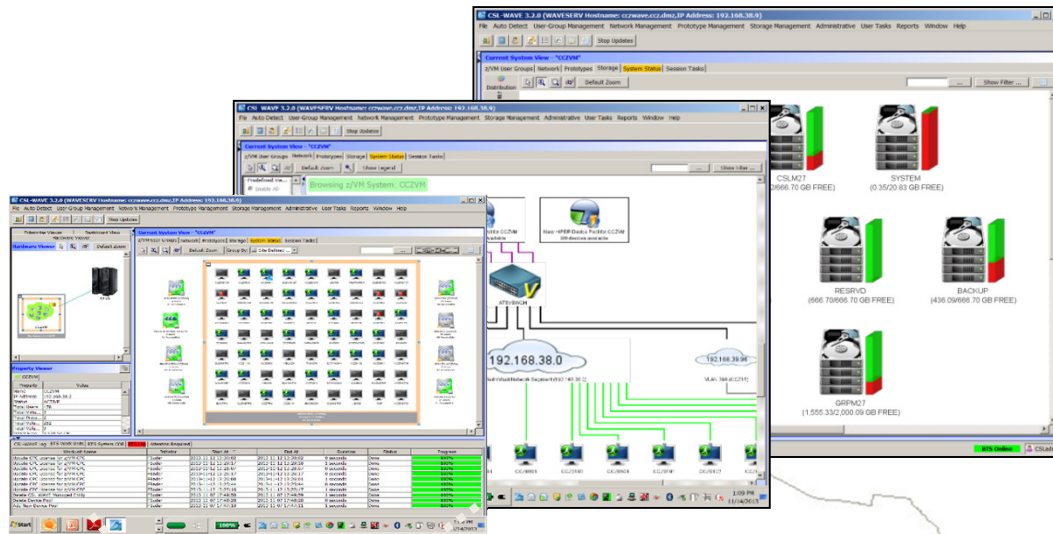

**IBM Advanced Technical Support**  
**Washington Systems Center**  
**Gaithersburg, MD**



**Client Sites Worldwide**

## **Hands on IBM Wave Environment now available**

- Client hands-on experience using IBM Wave on a IBM zEnterprise EC12 (zEC12)
- Secure remote access from client site to zEC12 in Gaithersburg, MD
- Accessible 24 hours a day, 7 days a week (except for occasional planned outages)
- Guided exercises provide hands on experience with IBM Wave
- Contact your representative to get started today

## STG Lab Services – IBM Wave Jumpstart Services for zEnterprise

- This Jumpstart service can help to accelerate your IBM Wave implementation
- This service offering provides planning, installation, and usage assistance
- We tailor the installation to your environment and provide skills transfer by reviewing common use cases of the interface with your support staff

### Key Features:

- This service helps accelerate the implementation and ROI with IBM Wave
- Assistance in planning the implementation by those who have implemented and used for several years
- Provide recommendations on integration and configuration in your environment
- Demonstrate how to implement custom REXX™ Execs with IBM Wave to extend functionality
- Integration with Microsoft AD for authentication
- Demonstration and review of common IBM Wave use cases with your staff in a workshop setting
- Demonstrate how to enable existing Linux servers to be managed by IBM Wave
- The Jumpstart is usually typically complete in one week depending upon the size of the deployment

### Target Audiences:

- zEnterprise z/VM and Linux Administrators
- Existing and First in Enterprise customers
- Organization who want augment the System z support staff with less experienced IT professionals

### Business Drivers:

- Reduced staff z/VM experience requirements
- Increased IT staff productivity
- Reduce systems management costs

### Contact:

- [stgls@us.ibm.com](mailto:stgls@us.ibm.com) for questions specific to this service.

**Our System z experts have years of experience working with IBM Wave dating back to before it became an IBM product**